

THE BOOK 6.0

> Lifting Technology

> Load Securing Technology

> Light Material Handling

> Application Technology



YOUR CONTACT PERSONS

Address

THIELE GmbH & Co. KG
Werkstr. 3 | 58640 Iserlohn | Germany
www.thiele.de

Sales service

Our friendly sales team is at your disposal for receiving and processing orders as well as for technical advice.

Business hours

Mo. – Th.: 8.00 – 16.30 hrs
Fr.: 8.00 – 16.00 hrs



Sales Director

Enrique Bermejo
+49 (0) 23 71 9 47-312
e.bermejo@thiele.de



Sales Manager

Alexandra Arndt
+49 (0) 23 71 9 47-320
a.arndt@thiele.de

Germany



Area Sales Manager Region North/East

Fiona Harris
+49 (0) 23 71 9 47-226
f.harris@thiele.de



Area Sales Manager Region West

Patrick Jas
+49 (0) 23 71 9 47-321
p.jas@thiele.de



Area Sales Manager Region South

Manfred Blach
+49 (0) 23 71 9 47-225
m.blach@thiele.de



Sales Manager

Canan Sahin
+49 (0) 23 71 9 47-314
c.sahin@thiele.de



Sales Representative Region West

Jörg Risse
+49 (0) 171 7639306
j.risse@thiele.de

Export



Area Sales Manager Export

Heiko Kurz
+49 (0) 23 71 9 47-223
h.kurz@thiele.de



Area Sales Manager Export

Dominik Werth
+49 (0) 23 71 9 47-204
d.werth@thiele.de



Sales Manager Export

Julia Hampel
+49 (0) 23 71 9 47-345
j.hampel@thiele.de



Sales Manager Export

Lisa Temp
+49 (0) 23 71 9 47-228
l.temp@thiele.de

CONTENT

	General Information	4
	THIELE-Lifting-Evolution	12
Lifting Technology	Lifting Products Grade 100	15
	Lifting Products Grade 80	53
	Offshore Lifting Products	97
	Lifting and Lashing Points	101
	Hoist Chains	121
	Load Lifting Equipment (Chain Blocks, Lever Blocks)	129
Load Securing Technology	Lashing Products	137
Light Material Handling	Poultry Chains	165
	Farming Chains	173
	Chain Sprockets	177
Application Technology	Fishing Chains	181
	Inspection Service	183
	Special Chains and System Solutions	185

General Information



THIELE GmbH & Co. KG

A partner you can rely on for chain systems and forgings

THIELE was established in Iserlohn-Kalthof more than 85 years ago and the company is now one of the world’s leading manufacturers of chain systems. The forging of quality components has become one of our core competence areas. Customers benefit from our established expertise in product design and manufacturing, with everything we supply being produced at our plant in Iserlohn, Germany.

As well as supplying the traditional markets for conveying and lifting equipment, we also operate in new future-oriented sectors like mobility and renewable energies.

Our company values are loyalty and respect. We believe in treating our customers as partners with a shared interest in developing successful, long-term business relationships based on product quality and punctual delivery.

Our ultimate goal is the optimal customer satisfaction based on fulfillment of the high quality, environmental and safety requirements that are placed on our products. For this purpose, THIELE has a quality management system certified according to ISO 9001 and an environmental management system certified according to ISO 14001.

THIELE is also certified according to ISO 50001 energy management system and ISO 45001 occupational health and safety management system.

The longevity of our high-quality products saves resources and protects the environment.

Therefore, they enjoy an excellent reputation among our customers worldwide.

Our promise

1. Our highly skilled workforce and modern manufacturing facilities guarantee products of the highest quality.
2. We will work with you to supply customer-specific products tailored to meet your requirements.
3. We are constantly improving our processes for enhanced resource efficiency and sustainability.





Our contribution to the environment

As a medium-sized company that operates internationally, we are aware of our responsibility towards customers, employees and the environment. To this end, THIELE is committed to meeting the high quality, environmental and safety requirements placed on our products and on us as a company at various levels. At THIELE, we see it as our duty to do our part to curb global warming.

THIELE has set itself the big goal of becoming climate-neutral by 2030. As a manufacturing industrial company, this objective represents a special challenge that we would like to face with motivation. The investment in a photovoltaic system and the use of heat recirculation systems are just a few examples. For us, the sustainable use of resources begins at the smallest level and runs through all business processes.

PV system - Green electricity for THIELE

The plant consists of 1,700 solar modules that generate up to 600,000 kWh of electricity annually. As a result, THIELE will not only save energy costs, but also about 300 tons of CO₂. The new plant is therefore a sustainable step towards CO₂ neutrality and at the same time offers further security of energy supply.

Electromobility

In cooperation with our local energy carrier, THIELE provides an electric car fleet for business drivers. This avoids unnecessary air pollution and protects the environment, especially for short distances.



General Information



YOUR
ONE-STOP
PROVIDER

Our range of services:

- Bending
- Forging
- Different welding processes
- Laser, plasma and flame cutting
- Multi-spindle milling machines
- CNC machining
- Assembly and end production
- Heat treatment
- Painting and surface finishing



Product development

Our in-house manufacturing base covers the entire process from raw material through to the final product. High-level expertise leads to short developing times, especially when new products are designed.



Modern 5-spindle machining centre



Manufacture of dies, trim dies and calibration tools

FEM simulation

With precise calculations and the experience of our engineering team we carry out stress analyses before production begins. This makes the product development process highly efficient and optimised to the maximum.



FEM simulation of a XKE-Point

Material flow simulation

3D simulations optimise the forging process, enable precise volume calculations, increase efficiency and have a positive impact on the product quality.

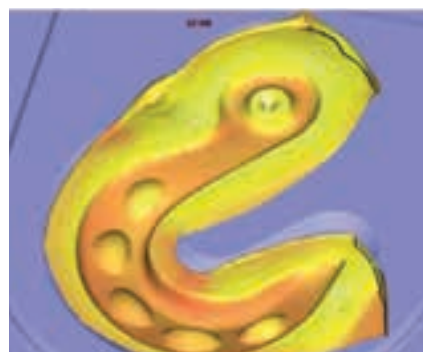

Material flow simulation



CNC machining





WHAT YOU CAN EXPECT FROM US

High added value and state-of-the-art forging aggregates

Our range services:

Forging machines (16 - 160 kJ) | forging presses (up to 1,600 t)
component weights from 100 g to 100 kgs | lengths up to 1,350 mm

Our forged products are based around a large selection of materials:

- Chain steels (DIN 17115)
- Non-alloy heat-treatable steels (DIN EN ISO 683-1)
- Alloy heat-treatable steels (DIN EN ISO 683-2)
- Case-hardened steels (DIN EN ISO 683-3)
- Non-alloy structural steels (DIN EN ISO 10025-2)

Special steels, e.g. high-alloy corrosion-resistant, heat-resistant and antimagnetic steels, are available on request.

Heat treatment:

A process-based heat treatment stage delivers the final product characteristics. Our state-of-the-art, fully automated heat treatment plant ensures that the end-products meet the highest mechanical requirements.

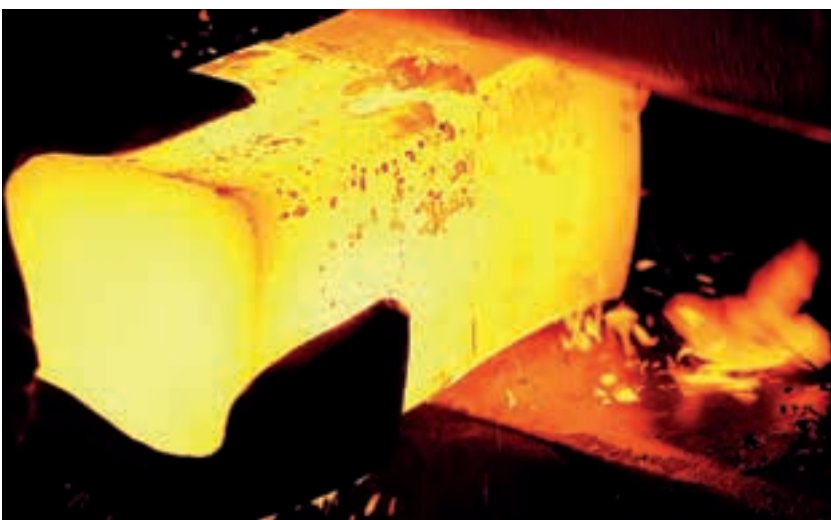

Square billets (edge length 50 to 120 mm) or round bar material (18.5 to 200 mm in diameter) can be used as raw material.



THIELE SEMINAR PROGRAM



More safety in handling lifting and lashing chains

We regularly train your employees to become experts in lifting technology and thus create more safety in your company.

Training as an expert in lifting technology

1-DAY-SEMINAR

The participants are trained for safe use of lifting equipments.

Training content:

- Chain and sling science
- Product and application notes
- Wear behaviour and discard criteria of slings
- Material testing and metallurgy of round steel chains and components
- Technical characteristics of round steel chains and components
- Insight to relevant standards
- Documentation and references
- Certificate of participation

Training as an expert in lifting technology

2-DAY-SEMINAR

After successful participation, the participants are entitled to check the slings in your company.

Training content

(in addition to the 1-day seminar):

- Introduction to DGUV-R 109-017 and DGUV I 209-013
- Legal bases
- Instruction to the DIN EN 818 and DIN EN 1677
- Product training
- Application examples, assembly of lifting chains
- Company tour
- Documentation and references
- Certificate of participation

Load Securing Technology

1-DAY-SEMINAR

The seminar is aimed to logistics managers, warehouse and dispatch managers, safety and hazardous goods agents, dispatchers, drivers and other persons in the field of load securing.

Training content:

- Legal basis (VDI guidelines 2700 ff, DGUV regulation 70, DIN/EN standards)
- Physical basics
- Requirements for transport vehicle
- Lashing points and load distribution
- Types of load securing
- Selection of lashing products and their testing requirements
- Further tools for load securing
- Certificate of participation

Further information

Send us an e-mail to Lifting-technology@thiele.de for more information.

Your THIELE seminar team

THIELE SERVICE

The Book 6.0

You can download our catalogue "The Book 6.0".



The Book 6.0

3D CAD Data

All user information, geometry data and CAD download can be found on the respective product pages of our website www.thiele.de.

This is the ideal support for your engineer department.



Website

Operating and Mounting Instructions

The operating and assembly instructions for all THIELE lifting products contain important information for a safe operation in the sense of the EC machinery directive. They must be read before operation.



Operating and mounting instructions

THIELE Chain Sling Configurator and Calculator (TKGK)

The THIELE chain sling configurator and calculator in the customer portal on our website makes it much easier for you to prepare appropriate offers. You save time and eliminate error sources at the assignment of components, the calculation of the part lengths and the summation of weights and costs. Just upload your company data and your logo. Set up your customized offer under consideration of commercial and technical aspects. You get a structured offer with a detailed specification.

SERVICE at THIELE is our utmost importance!

Please ask for your login data.

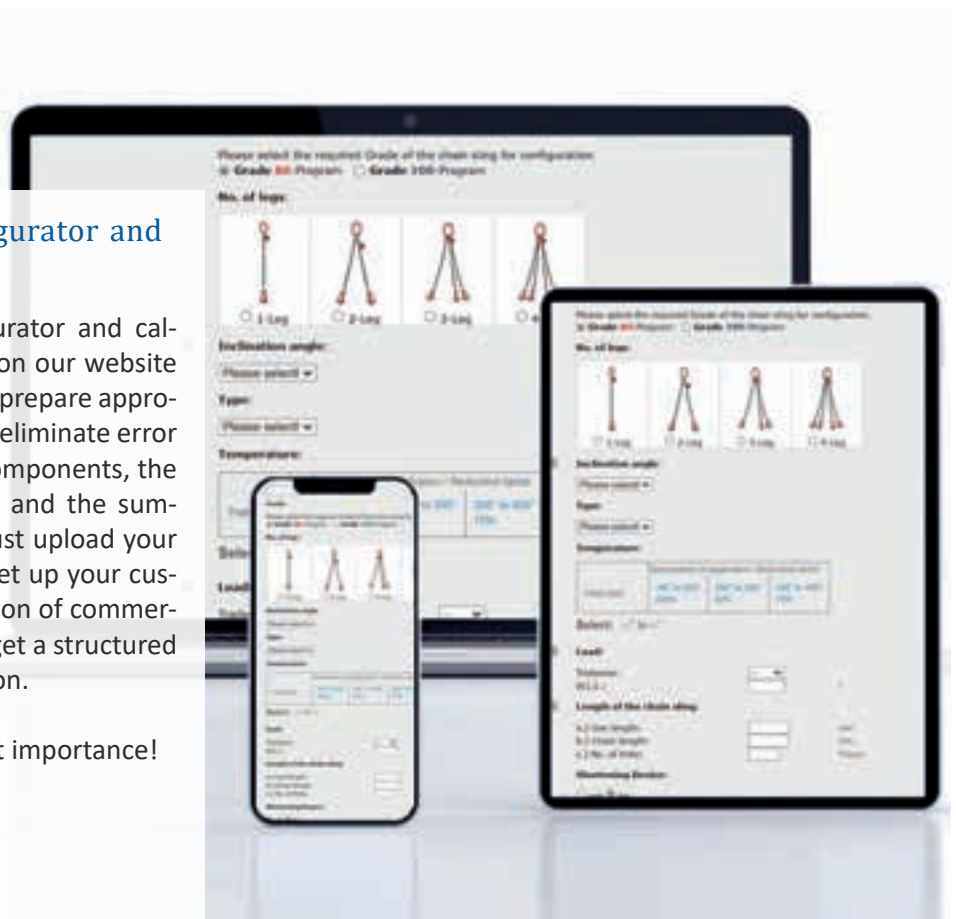

THIELE-LIFTING-EVOLUTION



is the brand feature of the THIELE Lifting components.



All new THIELE lifting components are developed with a new design. The new corporate design ensures the characteristic differentiation of the THIELE brand. For more than 85 years, THIELE stands for durable reliability and for high value quality. This added value for safety and certainty of THIELE components for lifting purposes is forged in ellipses style shaping. Our experience with other products in use have shown that the assured product properties are not always being kept. Standards are often cited but not extensively fulfilled. The requirements on safety for lifting products are more than a determination of a breaking force only. Also the intensity of intermediate quality controls in the production make a

large difference in the end result of the quality of the product. Our motto:

“At THIELE you always know, what you get!”

The new shaping with ellipses shall help as an orientation, particularly for the user. Furthermore, the ellipses make our product more modern and dynamic. Lifting, moving and securing of loads can also be shapely. The

ellipses of the components are reflecting what a lot of our customers are already expecting from our products since decades:

In particular a continuous standard of high quality. The result of years of experience with controlled and safer sophisticated processes in production “MADE BY THIELE!”



Not available on Connectors, Master Links and Lifting Points.

Our Product Range



TA10
Lifting Products
Grade 100



TA8
Lifting Products
Grade 80



TAO
Lifting Products
Offshore

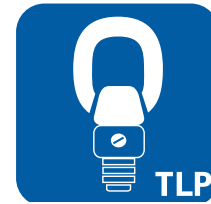

TLP
Lifting Points



THK
Hoist Chains



TLA
Load Lifting Equipment

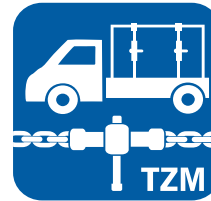

TZM
Lashing Products



TGK
Poultry Chains



TLK
Farming Chains



TKR
Chain Sprockets



TFK
Fishing Chains



TPS
Inspection Service



TCE
Engineering

Our Product Features



100 % crack-tested



Safety factor 4:1
BF $\geq 2 \times$ LC



With roller bearings



CE marked



Safety factor 4:1
BF $\geq 4 \times$ WLL



Swivel range $> 180^\circ$



Certified by German
Employer's Liability
Insurance Association



Safety factor Lifting 4:1
BF $\geq 4 \times$ WLL
Safety factor Lashing 2:1
BF $\geq 2 \times$ LC



Rotation 360°



THIELE international - THIELE booth at the BAUMA in Munich



You can find more impressions of the THIELE booth at the BAUMA 2022 on YouTube:



SCAN ME





THIELE®

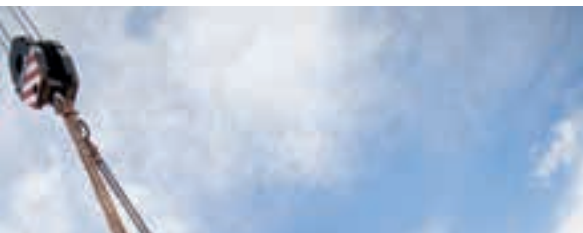

THIELE
LIFTING PRODUCTS

Grade 100





Product Overview - Lifting Products Grade 100

Page
27-28

Round Steel Chains

TWN 1805 (XL400)



TWN 0072 (XL200)

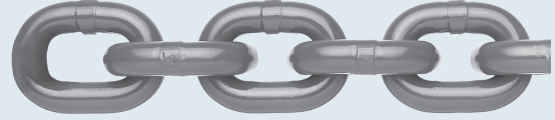

Pages
29-33

Suspension Components

TWN 1795



TWN 1813



TWN 1814



TWN 1815



TWN 1816



TWN 1810/1



TWN 1810/2



TWN 1810/4



TWN 1819



Pages
33-34

Connectors

TWN 1820



TWN 1847



Pages
34-38

Hooks

TWN 1836



TWN 1837



TWN 1838



TWN 1840/1



TWN 1841/1



TWN 1856



TWN 1899









TWN 1869



TWN 0869/1



Pages 39-41	Shortening Components				
	TWN 1827	TWN 1827/1	TWN 1851/1	TWN 1852	TWN 1896
					

Page 41	Shackles				
TWN 1871					
					

Page 42	Chain Tensioners				
TWN 1454	TWN 1455				
					





Product Overview - Lifting Products Grade 100



Page 43	Special Sling Components				
	TWN 1812 	TWN 1846 			

Pages 43-44	Lashing Chains			
	TWN 1410 	TWN 1411 		

Pages 44-48	Spare Parts and Accessoires				
	TWN 0944 	TWN 0945 	TWN 0968 	TWN 0969 	TWN 0970
	TWN 0971 	TWN 1402 	TWN 1904/0 	TWN 1908/0 	TWN 1921
	TWN 1922 	TWN 1930/0 	TWN 1931/0 	TWN 1933/0 	TWN 1933/0A
TWN 1935 	TWN 1935A 	TWN 1940 	TWN 1946 	TWN 1950 	

Pages 49-50	Chain Slings		
<p>TWN 1601 1-leg</p> 	<p>TWN 1651 2-leg</p> 	<p>TWN 1751 4-leg</p> 	

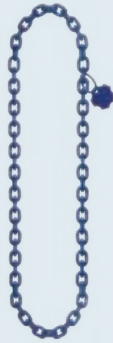
Page 51	Shortening Options		
			

Page 52	Endless Chains		
<p>Type K11</p> 	<p>Type K12</p> 	<p>Type K22</p> 	



Comparison between Grade 80 and Grade 100

Up to 35 % weight reduction on a 2-leg Grade 100 chain sling compared to equivalent Grade 80 chain sling.

Article	THIELE Plant Standard	Pieces
Master Link	TWN 1813	1
XL-LOK	TWN 1820	2
2 m Round Steel Link Chain	TWN 1805	2
Clevis Sling Hook	TWN 1840/1	2

Working Load Limit [t]	TA8 Weight [kgs]	TA10 Weight [kgs]	Weight reduction [%]
3,55	9,3	6,5	-30
5,60	16,5	10,6	-35
9,00	26,8	18,4	-31



Properties	Grade	TA8	TA10 - XL400
Working Load Limit (WLL)			app. +25 %
Safety Factor		4	4
Elongation at break (completed finish)		min. 20 %	min. 20%
Weight			reduced up to 35 %
Nominal Breaking Stress		800 N/mm ²	1000 N/mm ²
Component Strength		1150-1250 MPa ¹⁾	1450-1550 MPa ¹⁾
Temperature Application Range		-40 – 200 °C (100 %) ²⁾ 200 – 300 °C (90 %) ²⁾ 300 – 400 °C (75 %) ²⁾	-30 – 200 °C (100 %) ²⁾ 200 – 300 °C (90 %) ²⁾ 300 – 380 °C (60 %) ²⁾
Acids and Lyes		not permitted	not permitted
Compatibility with other systems		permitted	restricted
Colour Round Steel Link Chains (AQUA lacquer)		Black (RAL 9005)	Ultramarine Blue (RAL 5002)
Colour Components		Red powder coated (RAL 3003)	Ultramarine Blue powder coated (RAL 5002)
Standards		DIN EN 818, DIN EN 1677	PAS 1061 (Manufactures Specification)
Wear Resistance		standard	increased

¹⁾ Reference value

²⁾ Related to Working Load Limit

Selection criteria for chain slings

1. Determine the weight of the load to be lifted.

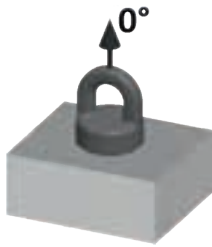

5. Consider that asymmetry may influence the load factor (see table 4 on page 27).

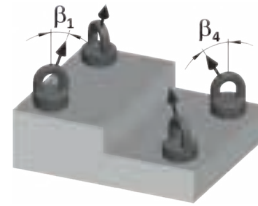

2. Determine number of chain-leg required (depending on the number of available lifting points).

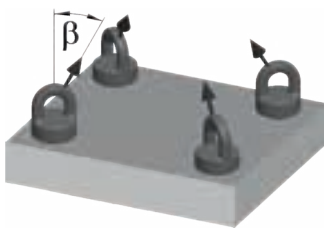

6. Specify the sling using components for the selected chain trade size.



3. Determine the trade size by taking the inclination angle into consideration (see table 1 on page 25 and table 2 and 3 on page 26).

7. Determine the chain length for each strand by considering the required effective reaches.

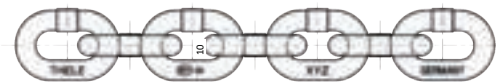

4. Consider possible temperature impacts (see load reductions on page 27).

8. Control selected components and/or chain slings to ensure that they meet applicable safety laws and regulations (e.g. DGUV).



Special Advices:

Please also consider special conditions of use, such as e.g. intermittent impacts on loads when selecting the grade 100 chain slings. If the chain slings were used above the maximum admissible temperature, they have to be immediately rejected. The THIELE-assembly systems must not be used with chemical influences such as acids and/or lyes.

Lifting products according to DIN EN 818-4 fulfill the requirements of the EC-directive for machines, especially for safety relevant components. The working load limit and the test requirements meet or exceed the European standards.

Identification Tags

The use of chain slings without identification tag is not permitted. The data on the identification tag must be in accordance with the standard DIN EN 818-4 for chain slings. THIELE Grade 100 identification tags differ by shape (decagon) and colour (blue, RAL 5002) from tags of other grades.

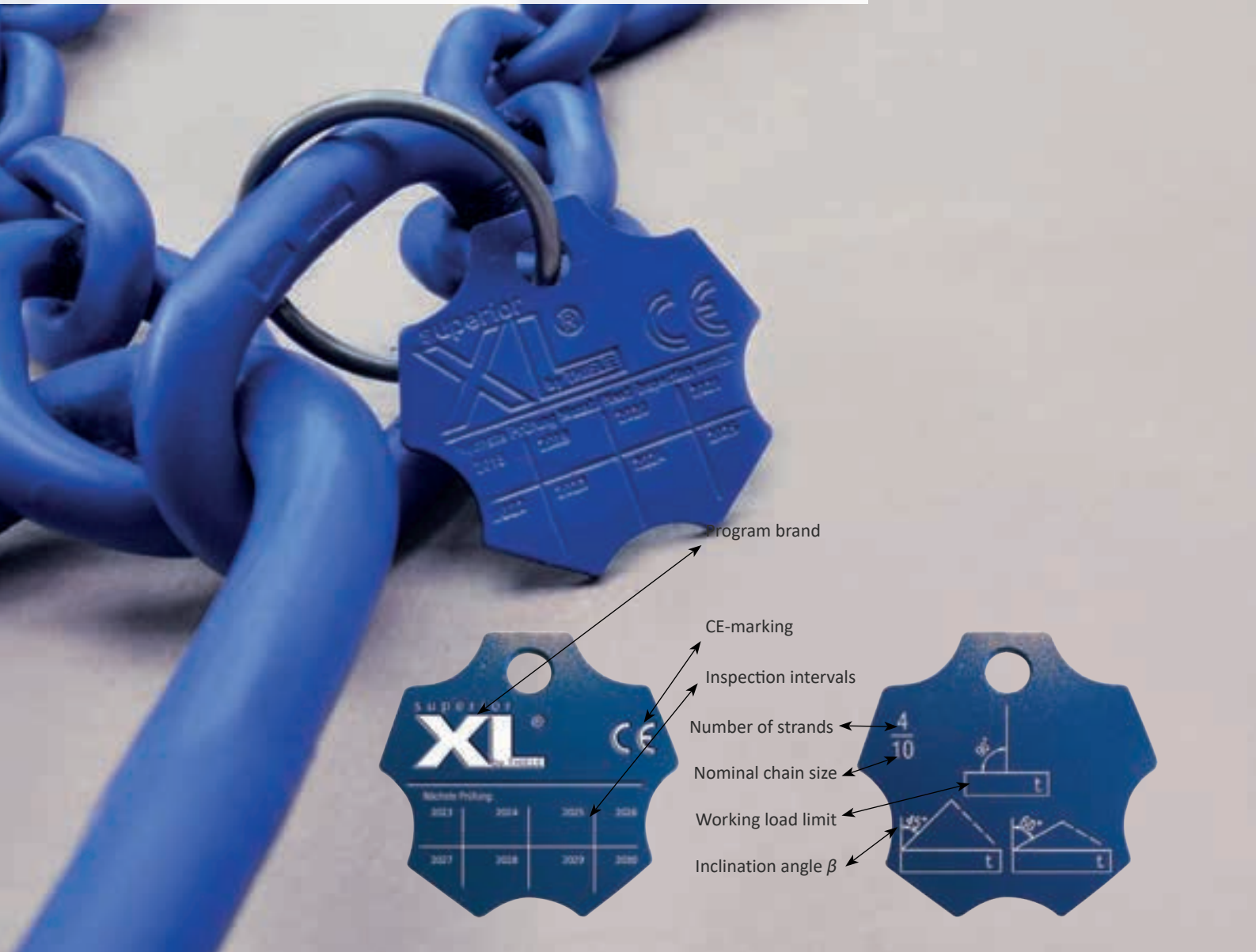

Legal Marking of Grade 100 Chains according to the German DGUV

The number "4" below the $\text{\textcircled{R}}$ is the registration number of the German statutory accident insurance (DGUV) and identifies the manufacturer of the sling. The marking is also recognized by all international certification societies and work authorities.

Chain Inspection Gauges

Check of diameter



TWN 1946

The THIELE chain measuring gauges TWN 1946 are used for the dimensional assessment of the state of wear and elongation of grade 100 round steel chains XL400 and XL200. It helps the user to inspect the round steel chains to ensure that they meet the requirements regarding to diameter, elongation and pitch tolerance.



TA10

Check of pitch



Check of permanent elongation





The DGUV-approved round steel chains **XL400** are stamped with »10«, »XL-400«, »Germany« and traceability code.

Round steel chains **XL200** are stamped with »T3-10«, »XL200«, »Germany« and traceability code.

Liability

THIELE does not take over liability of Grade 100 slings being combined with products from other manufactures.

Assembly

The combination of different grades when mounting chain slings is prohibited.

Grade 100 round steel chains are only allowed to be assembled to original Grade 100 Components of the corresponding trade size.

Only original THIELE spare parts may be used when making repairs.

Material

For the production of grade 100 products, only alloy steels according to DIN 17115 are used.

Safety Information

Our products are to be used only according to the prescribed guidelines.



Incorrect use, overload or damage can lead to injury or death! Installation and operation of chain slings only permitted by trained and skilled personnel. Before commissioning slings, please pay attention to the mounting and operating instructions. They may be found on our website www.thiele.de.



*Operating and
mounting
instructions*

Working Load Limit Tables

Working Load Limit – Type: Direct Lift (Chain Slings)

		1-leg	2-leg		3-/ 4-leg	
						
Inclination Angle		$\beta = 0^\circ$	$0^\circ < \beta \leq 45^\circ$	$45^\circ < \beta \leq 60^\circ$	$0^\circ < \beta \leq 45^\circ$	$45^\circ < \beta \leq 60^\circ$
Load Factor		1	1,4	1	2,1	1,5
Trade Size	Nominal Size [mm]	[t]	[t]	[t]	[t]	[t]
6-10	6	1,40	2,00	1,40	3,00	2,12
7-10	7	1,90	2,65	1,90	4,00	2,80
8-10	8	2,50	3,55	2,50	5,30	3,75
10-10	10	4,00	5,60	4,00	8,00	6,00
13-10	13	6,70	9,00	6,70	14,00	10,00
16-10	16	10,00	14,00	10,00	21,20	15,00
20-10	20	16,00	22,40	16,00	33,50	23,60
22-10	22	19,00	26,50	19,00	40,00	28,00
26-10	26	26,50	37,50	26,50	56,00	40,00
32-10	32	40,00	56,00	40,00	85,00	60,00

THIELE chain slings are available in mounted and welded execution.

Table 1

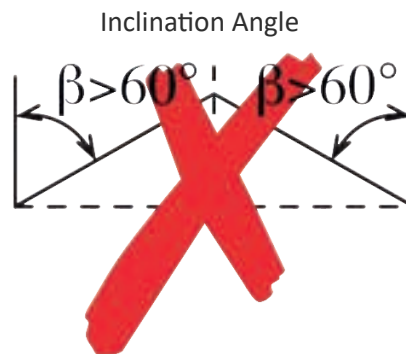

Types of endless chains:

Type K11





Type K12



Type K22





Working Load Limit – Type: Choke Hitch (Chain Slings)

		1-leg	2-leg	
				
Inclination Angle		$\beta = 0^\circ$	$0^\circ < \beta \leq 45^\circ$	$45^\circ < \beta < 60^\circ$
Load Factor		0,8	1,12	0,8
Trade Size	Nominal Size [mm]	[t]	[t]	[t]
6-10	6	1,12	1,60	1,12
7-10	7	1,50	2,12	1,50
8-10	8	2,00	2,80	2,00
10-10	10	3,15	4,50	3,15
13-10	13	5,30	7,50	5,30
16-10	16	8,00	11,20	8,00
20-10	20	12,50	18,00	12,50
22-10	22	15,00	21,20	15,00
26-10	26	21,20	30,00	21,20
32-10	32	31,50	45,00	31,50

THIELE chain slings are available in mounted and welded execution.

Table 2

Working Load Limit – Type: Choke Hitch (Endless Chains)

		K11		K12/K13		K22/K23	
							
Inclination Angle		$\beta = 0^\circ$	$0^\circ < \beta \leq 25^\circ$	$0^\circ < \beta \leq 45^\circ$	$45^\circ < \beta \leq 60^\circ$	$0^\circ < \beta \leq 45^\circ$	$45^\circ < \beta < 60^\circ$
Load Factor		1,6	1,45	1,12	0,8	1,7	1,2
Trade Size	Nominal Size [mm]	[t]	[t]	[t]	[t]	[t]	[t]
6-10	6	2,24	2,00	1,60	1,12	2,36	1,70
7-10	7	3,00	2,80	2,12	1,50	3,15	2,24
8-10	8	4,00	3,55	2,80	2,00	4,25	3,00
10-10	10	6,30	5,60	4,50	3,15	6,70	4,75
13-10	13	10,60	9,50	7,50	5,30	11,20	8,00
16-10	16	16,00	14,00	11,20	8,00	17,00	11,80
20-10	20	25,00	22,40	18,00	12,50	26,50	19,00
22-10	22	30,00	28,00	21,20	15,00	31,50	22,40
26-10	26	42,50	37,50	30,00	21,20	45,00	31,50
32-10	32	63,00	56,00	45,00	31,50	67,00	47,50

THIELE chain slings are available in mounted and welded execution.

Table 3

Load Reduction Factors

Temperature Application Range XL200 and XL400 of Lifting Chains

Lifting Chains XL200

Temperature Application Range	W.L.L.
-40 °C to 205 °C	100 %

Lifting Chains XL400

Temperature Application Range	W.L.L.
-30 °C to 200° C	100 %
over 200 °C to 300 °C	90 %
over 300 °C to 380 °C	60 %

Load Factors at Asymmetry

Numer of Chain Strands	1		2		3		4	
	Inclination Angle β		Inclination Angle β		Inclination Angle β		Inclination Angle β	
Inclination Angle β	-	0° - 45°	46° - 60°	0° - 45°	46° - 60°	0° - 45°	46° - 60°	
Load Factor	1	1,4	1	2,1	1,5	2,1	1,5	

Table 4

Lifting Chains XL400

The grade 100 lifting chains XL400 are made from CrNiMo alloy steel and are used to assemble chain slings and lashing chains. The max. application temperature is 380°C. The testing requirements for these high-quality round steel chains are based on the DIN EN 818, PAS 1061 and on the German Statutory Accident Insurance test principle GS-HM 37. The lifting chains are especially characterized by their certified fatigue strength.



Trade Size	Article-No.	Working Load Limit [t]	Nominal Size d [mm]	Pitch p [mm]	Inside Width w_3 [mm] min.	Outside Width w_2 [mm] max.	Weight app. [kgs/m]
6-10	F01610B	1,40	6	18	8,40	22,20	0,89
8-10	F01615B	2,50	8	24	11,30	29,60	1,59
10-10	F01622B	4,00	10	30	13,40	37,00	2,48
13-10	F01629B	6,70	13	39	18,00	48,10	4,18
16-10	F01635B	10,00	16	48	21,40	59,20	6,34
20-10	F01638B	16,00	20	60	26,80	74,00	9,91
22-10	F01650B	19,00	22	66	29,50	81,40	12,00
26-10	F01660B	26,50	26	78	34,80	96,20	16,70
32-10	F01670B	40,00	32	96	42,80	118,40	26,10

TWN 1805





Lifting Chains XL400 and XL200

TWN 0072

Lifting Chains XL200

Grade 100 lifting chains XL200 are made from CrNiMo alloyed steel and are used to assemble chain slings and lashing chains. The max. application temperature is 205°C. The testing requirements for these high-quality lifting chains are based on the DIN EN 818 and ASTM 973.

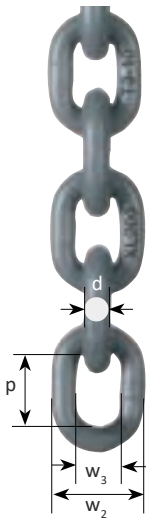

Trade Size	Article-No.	Working Load Limit [t]	Nominal Size d_n [mm]	Pitch p_n [mm]	Inside Width w_3 [mm] min.	Outside Width w_2 [mm] max.	Weight app. [kgs/m]
6-10	F01616	1,40	6	18	8,40	22,20	0,80
7-10	F01621	1,95	7	21	9,53	25,90	1,10
8-10	F01617	2,60	8	24	11,30	29,60	1,50
10-10	F01618	4,00	10	30	13,40	37,00	2,30
13-10	F01619	6,80	13	39	18,00	48,10	3,90
16-10	F01620	10,30	16	48	21,40	59,20	5,80
18-10	F01642	12,50	18	54	24,10	66,60	7,40

Comparison between Lifting Chains XL400 and XL200

Properties	Chain Type	XL400	XL200
Standard		PAS 1061 (Manufacturers specification)	ASTM 973
Material		High alloy steel	Alloy steel
Temperature Application Range		-30 °C up to 380 °C; reduction starting at 200 °C	-40 °C up to 205 °C
Working Load Limit (WLL)		25 % higher than Grade 80	25 % higher than Grade 80
Manufacturers Proof Force (MPF)		min. 2,5 x WLL	min. 2 x WLL
Breaking Force (BF)		min. 4 x WLL	min. 4 x WLL
Elongation at break		min. 20 %	min. 20 %
Charpy Notch Value		min. 42 J at -20 °C	min. 36 J at -30 °C, min. 27 J at -40 °C
Deflection		min. 0,8 x d	min. 0,8 x d
Fatigue		(1,5 x WLL) min. 20.000 LW	No requirement
Material properties (stress corrosion)		According to standard	No requirement
Finish		Galvanizing not permitted	Galvanizing not permitted
Colour (solvent-free)		Ultramarine blue (RAL 5002)	Grey (RAL 7011)
Marking		XL400; 10, Germany, ID-Code	XL200; T3-10, Germany, ID-Code
Certification		DGUV	THIELE
Market compliance		MRL / EAC	ASME, MD / EAC

Suspension Components

Master Links Form A for 1- and 2-leg Chain Slings

The grade 100 master links TWN 1813 are used to assemble 1- and 2-leg chain slings. The manufacturing and testing requirements are based on DIN EN 1677 parts 1 and 4, under consideration of grade 100 load capacities. The dimensions comply with the DIN 5688-3 and enable the use of connecting links, e.g. XL-LOKS TWN 1820. The possibility of using the links for single- and double-leg chain slings offers a high flexibility and economical warehousing. Furthermore, the master links can be used for example to assemble wire rope slings according to the DIN EN 13414-1.



Article-No.	Working Load Limit $0^\circ < \beta \leq 45^\circ$ [t]	Dimensions [mm]			Weight app. [kgs]	Trade Size for use in Chain Slings	
		d	t	b		1-leg	2-leg
F1813013	2,50	13	90	50	0,29	6/7-10	6-10
F1813016	4,00	16	110	60	0,53	8-10	(7-10)
F1813018	5,00	18	130	70	0,79	10-10	8-10
F1813020	6,00	20	140	80	1,10	-	10-10
F1813022	7,10	22	160	90	1,50	13-10	-
F1813026	10,00	26	180	100	2,30	16-10	13-10
F1813032	15,00	32	230	125	4,40	18-10	16-10
F1813036	20,00	36	250	140	6,20	20/22-10	18-10
F1813040	23,60	40	290	160	8,80	-	20-10
F1813045	30,00	45	320	175	12,00	26-10	22-10
F1813050	40,00	50	340	190	16,00	32-10	26-10
F1813056	50,00	56	380	210	23,00	-	-
F1813063	60,00	63	430	240	33,00	-	32-10
F1813070	75,00	70	470	260	44,00	-	-

TWN 1813

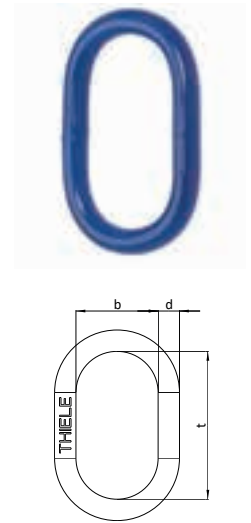

TA10

Master Link Assemblies for 3- and 4-leg Chain Slings

The grade 100 master link assemblies TWN 1814 are used to assemble 3- and 4-leg chain slings. The manufacturing and testing requirements are based on the DIN EN 1677 parts 1 and 4. The dimensions comply with the DIN 5688-3 and enable the use of connecting links, e.g. XL-LOKS TWN 1820. Furthermore, the master link assemblies can be used e.g. to assemble wire rope slings according to the DIN EN 13414-1.



Article-No.	Working Load Limit $0^\circ < \beta \leq 45^\circ$ [t]	Dimensions [mm]							Weight app. [kgs]	Trade Size for use in Chain Slings
		d ₁	t ₁	b ₁	e	d ₂	t ₂	b ₂		
F1814016	4,00	16	110	60	170	13	60	30	0,94	6-10
F1814020	6,00	20	140	80	210	16	70	35	1,80	7/8-10
F1814026	10,00	26	180	100	270	20	90	45	3,80	10-10
F1814032	15,00	32	230	125	350	26	120	60	7,70	13-10
F1814040	23,60	40	290	160	420	28	130	65	13,00	16-10
F1814050A	NEW 33,50	50	340	190	500	36	160	80	25,00	20-10
F1814050	40,00	50	340	190	520	40	180	90	28,00	22-10
F1814063	60,00	63	430	240	630	45	200	100	49,00	26-10
F1814080	85,00	80	520	290	740	50	220	110	86,00	32-10

TWN 1814

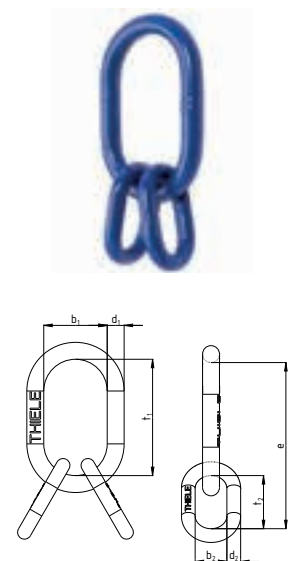

TWN 1815

Master Link Assemblies for 3- and 4-leg Rope Slings

NEW

The grade 100 master link assemblies TWN 1815 are used to assemble 3- and 4-leg wire rope slings. The extra large intermediate links enable an easy assembly of wire rope slings. The manufacturing and testing requirements are based on the DIN EN 1677 parts 1 and 4, under consideration of grade 100 load capacities. The dimensions comply with the DIN 5688-3.

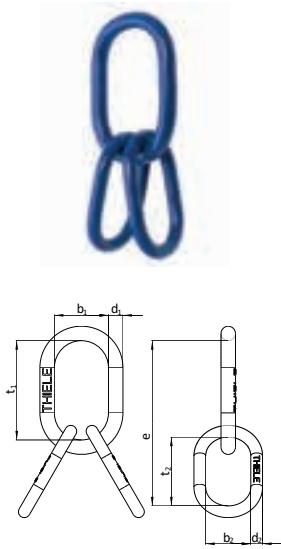

Article-No.	Working Load Limit $0^\circ < \beta \leq 45^\circ$ [t]	Dimensions [mm]							Classification ¹⁾ of the Wire Rope Diameter*		Weight app. [kgs]
		d ₁	t ₁	b ₁	e	d ₂	t ₂	b ₂	Fiber [mm]	Steel [mm]	
F1815016	3,50	16	110	60	200	13	90	50	12	11	1,11
F1815018	5,00	18	130	70	240	16	110	60	14	14	1,85
F1815022	6,60	22	160	90	290	18	130	70	16	16	3,08
F1815026	9,30	26	150	100	340	22	160	90	20	18	5,40
F1815032	13,90	32	230	125	410	26	180	100	24	22	9,10
F1815036	20,00	36	250	140	480	32	230	125	28	28	15,00
F1815045	26,30	45	320	175	540	36	250	140	32	32	24,40
F1815050	40,00	50	340	190	660	45	320	175	40	40	40,40
F1815056	50,20	56	380	210	720	50	340	190	44	44	55,40
F1815063	62,60	63	430	240	810	56	380	210	52	48	78,40
F1815085	127,20	85	520	290	1040	80	520	290	60	60	201,00

*Acc. to the DIN EN 13414-1

¹⁾ The classification for use in the 3 / 4 strand takes into account an angle of inclination of $0^\circ < \beta \leq 45^\circ$.

TWN 1816

Oversized Master Link Assemblies for 2-leg Chain Slings for Single Crane Hook DIN 15401 (16 t, 25 t)

NEW

The grade 100 oversized master link assemblies TWN 1816 are used to assemble 2-leg chain slings and are used with big crane hooks according to the DIN 15401. The manufacturing and testing requirements are based on the DIN EN 1677 parts 1 and 4, under consideration of grade 100 load capacities. The dimensions comply with the DIN 5688-3. The intermediate links enable the use of connecting links, e.g. XL-LOKS TWN 1820.

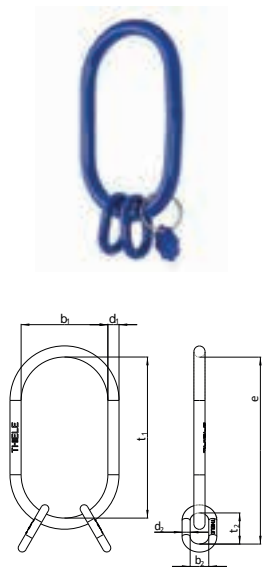

Trade Size	Article-No.	Working Load Limit $0^\circ < \beta \leq 45^\circ$ [t]	Dimensions [mm]							Assignment to crane hooks acc. to the DIN 15401 [No.]	Weight app. [kgs]
			d ₁	t ₁	b ₁	e	d ₂	t ₂	b ₂		
8-10	F18160816	3,55	22	260	140	330	16	70	35	16	2,96
8-10	F18160825	3,55	24	340	180	410	16	70	35	25	4,14
10-10	F18161025	5,60	28	340	180	410	16	70	35	25	5,43
13-10	F18161325	9,00	32	340	180	430	20	90	45	25	7,68
16-10	F18161625	14,00	40	340	180	440	22	100	50	25	11,90
20-10	F18162025	22,40	45	340	180	480	32	140	70	25	18,60

Suspension Components

Intermediate Links Type B

The grade 100 intermediate links TWN 1795 are used to manufacture chain slings. The dimensions are according to the DIN 5688-3 and enable the use of connecting links, e.g. XL-LOKS TWN 1820. The manufacturing and testing requirements are based on DIN EN 1677 parts 1 and 4, under consideration of grade 100 load capacities.



Trade Size	Article-No.	Working Load Limit $0^\circ < \beta \leq 45^\circ$ [t]	Dimensions [mm]			Weight app. [kgs]
			d	t	b	
B8	F179508	1,40	8	36	18	0,05
B10	F179510	2,50	10	46	23	0,09
B13	F179513	4,00	13	60	30	0,20
B16	F179516	6,70	16	70	35	0,36
B20	F179520	10,00	20	90	45	0,73
B22	F179522	12,50	22	100	50	0,97
B26	F179526	16,00	26	120	60	1,60
B28	F179528	19,00	28	130	65	1,90
B32	F179532	26,50	32	140	70	2,90
B36	F179536	31,30	36	160	80	4,20
B40	F179540	40,00	40	180	90	5,80
B45	F179545	50,00	45	200	100	8,20

TWN 1795

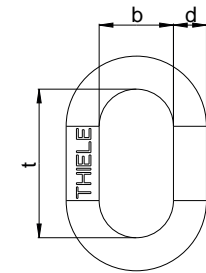

TA10

Fixed Size Master Links TAA1 for 1-leg Chain Slings

The grade 100 fixed size master links TWN 1810/1 are used to assemble 1-leg chain slings. The permanently installed ring shackles enable the assembly of lifting chains of the appropriate nominal size only. The dimensions of the fixed size master links type A comply with the DIN 5688-3. Welded-in identification tags contain all the necessary data for the operator. The manufacturing and testing requirements are based on the DIN EN 1677 parts 1 and 4, under consideration of grade 100 load capacities.



Trade Size	Article-No.	Working Load Limit $0^\circ < \beta \leq 45^\circ$ [t]	Dimensions [mm]				Weight app. [kgs]
			d	t	b	e	
6-10	F1810106	1,40	13	90	50	121	0,40
8-10	F1810108	2,50	16	110	60	147	0,71
10-10	F1810110	4,00	18	130	70	176	1,20
13-10	F1810113	6,70	22	160	90	219	2,33
16-10	F1810116	10,00	26	180	100	256	3,90
22-10*	NEW F1810122	19,00	36	250	140	350	10,10

*On request

TWN 1810/1

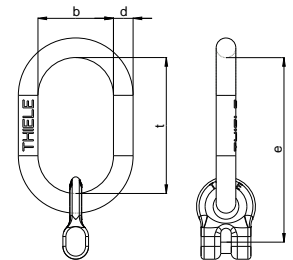

TWN 1810/2

Fixed-Size Master Links TAA2 for 2-leg Chain Slings

The grade 100 fixed size master links TWN 1810/2 are used to assemble 2-leg chain slings. The permanently installed ring shackles allow the assembly of lifting chains of the appropriate nominal size only. The dimensions of the fixed size master links type A comply with the DIN 5688-3. The manufacturing and testing requirements are based on the DIN EN 1677 parts 1 and 4, under consideration of grade 100 load capacities. Welded-in identification tags contain all the necessary data for the operator.

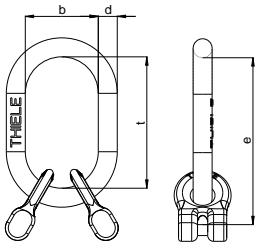

Trade Size	Article-No.	Working Load Limit $0^\circ < \beta \leq 45^\circ$ [t]	Dimensions [mm]				Weight app. [kgs]
			d	t	b	e	
6-10	F1810206	2,00	13	90	50	121	0,50
8-10	F1810208	3,55	18	130	70	167	1,20
10-10	F1810210	5,60	20	140	80	186	1,90
13-10	F1810213	9,00	26	180	100	239	4,00
16-10	F1810216	14,00	32	230	125	296	7,60
22-10*	NEW F1810222	26,50	45	320	175	420	19,80

*On request

TWN 1810/4

Fixed-Size Master Links TAA4 for 3- and 4-leg Chain Slings

The grade 100 fixed size master links TWN 1810/4 are used to assemble 3- and 4-leg chain slings. The permanently installed ring shackles allow the assembly of lifting chains of the appropriate nominal size only. The dimensions of the fixed size master links type A comply with the DIN 5688-3. The manufacturing and testing requirements are based on the DIN EN 1677 parts 1 and 4, under consideration of grade 100 capacities. Welded-in identification tags contain all the necessary data for the operator.

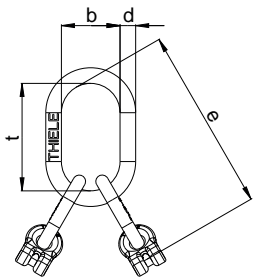

Trade Size	Article-No.	Working Load Limit $0^\circ < \beta \leq 45^\circ$ [t]	Dimensions [mm]				Weight app. [kgs]
			d	t	b	e	
6-10	F1810406	3,00	16	110	60	201	1,40
8-10	F1810408	5,30	20	140	80	247	2,70
10-10	F1810410	8,00	26	180	100	316	5,40
13-10	F1810413	14,00	32	230	125	409	11,20
16-10	F1810416	21,20	40	290	160	495	19,40
22-10*	NEW F1810422	40,00	50	340	190	620	43,20

*On request

Suspension Components/ Connectors

Clevis Master Links

The grade 100 clevis master links TWN 1819 are predominantly used to assemble basket slings for bundling of loads. The manufacturing and testing requirements are based on the DIN EN 1677-1, under consideration of grade 100 load capacities.



Trade Size	Article-No.	Working Load Limit [t]	Dimensions [mm]							Weight app. [kgs]
			a	b	c	e	f	g	h	
13-10	F31025	6,70	189	102	32	142,5	60	110	22	1,11

TWN 1819

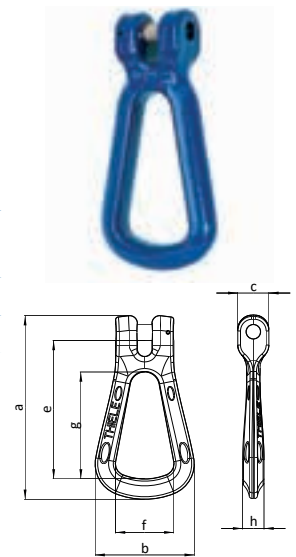

Connectors

XL-LOK Connecting Links

The grade 100 XL-LOK connecting links TWN 1820 are used to connect lifting chains with sling components to assemble chain slings and lashing chains. The manufacturing and testing requirements are based on DIN EN 1677-1, under consideration of grade 100 load capacities.



Trade Size	Article-No.	Working Load Limit [t]	Dimensions [mm]						Weight app. [kgs]
			a	b	c	e	f	g	
6-10	F30807	1,40	61	12	38,5	45	8	14	0,07
7-10	NEW F308090	1,90	71	14	47	50,5	9	16	0,14
8-10	F30817	2,50	85	16	55	62	10	19	0,20
10-10	F30827	4,00	97	18	66,5	72	13	24	0,35
13-10	F30837	6,70	125	23	82,5	87	17	28	0,74
16-10	F30847	10,00	146	31,5	109	105	21	34	1,20
20-10	NEW F308570	16,00	178,5	37	143,5	127,5	25	45	2,80
22-10	NEW F308670	19,00	196,5	40,5	150,5	140,5	27,5	45	3,50
26-10	NEW F308770	26,50	232	47,5	178	166	33	56	5,80
32-10	NEW F308870	40,00	285,5	58,5	220,5	204	40	70	10,9

TWN 1820

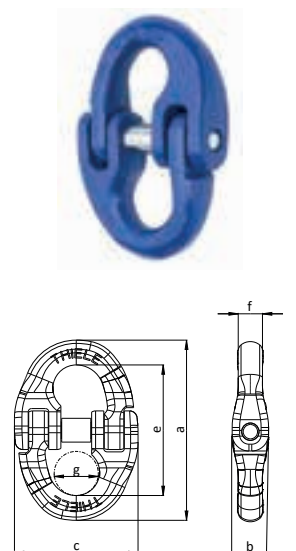



TWN 1847

Open Ring Shackles NEW

The innovative grade 100 open ring shackles TWN 1847 are used as a fixed size connection of lifting chains with sling components to assemble chain slings. For the correct assignment of the nominal size of the suspension links, the ring shackles are provided with a diameter indication forged on the body. The ring shackles provide an optimized, almost non-interchangeable and safe connection option for the simple assembly of chain slings. The manufacturing and testing requirements are based on DIN EN 1677-1 under consideration of the grade 100 load capacities.

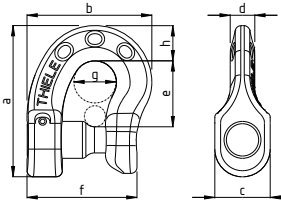

Trade Size	Article-No.	Working Load Limit [t]	Dimensions [mm]								Weight app. [kgs]
			a	b	c	e	f	g	d	h	
6-10*	F31705	1,40	-	-	-	-	-	-	-	-	0,25
8-10*	F31715	2,50	-	-	-	-	-	-	-	-	0,30
10-10	F31725	4,00	76	64	28	34	57	21	14	19	0,37
13-10	F31735	6,70	99	82	36	43	72	27	16	23	0,77
16-10*	F31745	10,00	-	-	-	-	-	-	-	-	1,00

*On request

Hooks

TWN 1836

Eye Self-Locking Hooks

The grade 100 eye self-locking hooks TWN 1836 are used to assemble lifting slings and are also used in the construction industry. The round steel chains may be assembled with connecting links, e.g. XL-LOKs TWN 1820. When the hooks are under load, they lock automatically. They may only be reopened manually, when the hooks are not under load anymore. The self-locking hooks comply with DIN EN 1677-3 under consideration of grade 100 load capacities.

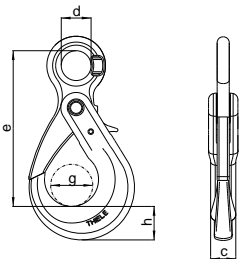

Trade Size	Article-No.	Working Load Limit [t]	Dimensions [mm]					Weight app. [kgs]
			d	e	c	g	h	
6-10* NEW	F092003	1,40	22	107	18	28	22	0,52
7/8-10* NEW	F092103	2,50	24	133	23	33	25	0,88
10-10* NEW	F092303	4,00	32	167	27	45	34	1,63
13-10* NEW	F092403	6,70	39	205	34	52	40	3,20
13-10 ¹⁾	F092233	6,70	40	209	32,5	53,5	40,5	2,92
16-10* NEW	F092503	10,00	49	262	43	64	53	6,33
16-10 ¹⁾	F092243	10,00	50	254	38	62	50,5	5,82
20-10* NEW	F092603	16,00	59	282	49	77	54	9,27
22-10* NEW	F092703	19,00	70	310	57	92	74	13,62
22-10 ¹⁾	F092273	19,00	70	319,5	52	80	66	11,74

*On request

¹⁾ TWN 1836A

Hooks

Clevis Self-Locking Hooks

The grade 100 clevis self-locking hooks TWN 1837 are used to assemble chain slings and are often used in the construction industry. The clevis design enables the direct attachment to the chain strands. When the hooks are under load, they lock automatically. They may only be reopened manually when the hooks are not under load anymore. The self-locking hooks comply with the DIN EN 1677-3, under consideration of grade 100 load capacities.



Trade Size	Article-No.	Working Load Limit [t]	Dimensions [mm]				Weight app. [kgs]
			e	c	g	h	
6-10*	NEW F0920031	1,40	98	18	28	22	0,59
7-10*	NEW F0920033	1,90	120	23	33	25	0,94
8-10*	NEW F092013	2,50	120	23	33	25	0,94
10-10*	NEW F092023	4,00	150	27	45	34	1,73
13-10*	NEW F092033	6,70	185	34	52	40	3,34
13-10 ¹⁾	F092032	6,70	182	32,5	53,5	40,5	3,00
16-10*	NEW F092043	10,00	220	43	64	53	6,58
16-10 ¹⁾	F092042	10,00	217	38	62	50,5	5,92
20-10*	NEW F092053	16,00	235	49	77	54	9,17
22-10*	NEW F092063	19,00	260	57	92	74	13,90
22-10 ¹⁾	F092072	19,00	276,5	52	80	66	12,31

*On request
¹⁾ TWN 1837A

TWN 1837



Swivel Self-Locking Hooks **NEW**

The grade 100 swivel self-locking hooks TWN 1838 are used to assemble chain- and wire rope- slings and are often used in the construction industry. The swivel with ball bearing allows the operator to swivel under load. When the hooks are under load, they lock automatically. They may only be reopened manually when the hooks are not under load anymore. The self-locking hooks comply with the DIN EN 1677-3 under consideration of grade 100 load capacities.



Trade Size	Article-No.	Working Load Limit [t]	Dimensions [mm]								Weight app. [kgs]
			e	c	g	b	d	f	h	l	
6-10	F0923003	1,40	120	16,5	28	30	10,5	18,5	25	180	0,60
8-10	F092313	2,50	201	23	33	43	14	33	25	242	1,00
10-10	F092323	4,00	240	27	45	49	16	38	34	289	2,00
13-10	F092333	6,70	303	34	52	57	21	49	40	363	3,80
16-10	F092343	10,00	340	43	64	60	23	49	53	410	7,00
20-10	F092353	16,00	380	49	77	80	27	68	54	470	9,60
22-10	F092363	19,00	471	57	92	99	33	99	74	573	13,00

TWN 1838

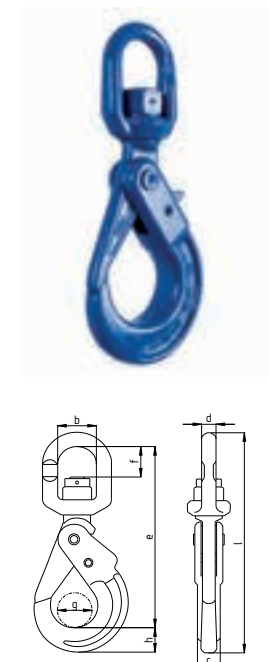



TWN 1840/1

Clevis Sling Hooks with Forged Safety Latch

The grade 100 clevis sling hooks with forged safety latch TWN 1840/1 are used to assemble standard chain slings and lashing chains. The clevis design enables the direct attachment to the lifting chain. The sling hooks comply with the DIN EN 1677-2, under consideration of grade 100 load capacities. Forged-in measuring points of the max. limit values of the hook opening enables easy control. The forged safety latch prevents an unintentional detachment from the load.

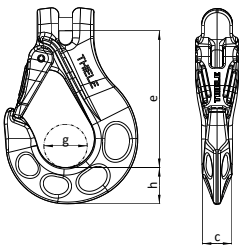

Trade Size	Article-No.	Working Load Limit [t]	Dimensions [mm]				Weight app. [kgs]
			e	g	h	c	
6-10	F336050	1,40	76	24	20	17	0,36
7-10	NEW F336070	1,90	91	26,5	22	20	0,53
8-10	F336150	2,50	94	30	25	22	0,76
10-10	F336250	4,00	114	37	32	28	1,41
13-10	F336350	6,70	134	42	41	35	2,48
16-10	F336450	10,00	162	51	50	41	4,40
20-10	NEW F336550	16,00	201	61	58	51	8,60
22-10	NEW F33664	19,00	223	70	62	55	11,50

TWN 1841/1

Sling Hooks with Eye and Forged Safety Latch

The grade 100 eye sling hooks with safety latch TWN 1841/1 are used to assemble standard chain slings. The round steel chains are assembled by using connecting links, e.g. XL-LOKs TWN 1820. The sling hooks comply with the DIN EN 1677-2, under consideration of grade 100 load capacities. Forged-in measuring points of the max. limit values of the hook opening enable easy control. The forged safety latches prevent unintentional detachment from the load.

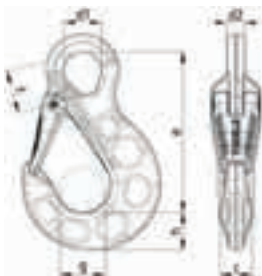

Trade Size	Article-No.	Working Load Limit [t]	Dimensions [mm]							Weight app. [kgs]
			e	d ₁	d ₂	g	h	c	f	
6-10	F32905	1,40	92	21 ¹⁾	11	24	20	17	-	0,36
7/8-10	F32915	2,50	118	28 ¹⁾	14	30	25	20	-	0,76
10-10	F32925	4,00	146	36 ¹⁾	18	37	32	29	-	1,50
13-10	F32935	6,70	168	42 ¹⁾	21	42	41	35	-	2,55
16-10	F32945	10,00	210	54 ¹⁾	25	51	50	41	-	4,65
20-10	NEW F32965	16,00	244	58 ¹⁾	27	62	59	51	-	7,61
22-10	F32975	19,00	271	65 ¹⁾	30	70	62	55	-	10,20
26-10	F32985	26,50	302	70	33	75	71	60	81	15,00
32-10	NEW F32995	40,00	350	80	38	90	84	70	99	24,30

¹⁾ With circular eyelet

Hooks

Eye Foundry Hooks NEW

The grade 100 eye foundry hooks with enlarged eye TWN 1856 are used to assemble chain slings predominantly for foundries. The round steel chains are assembled by using connecting links, e.g. XL-LOKs TWN 1820. The manufacturing and testing requirements comply with the DIN EN 1677-1, under consideration of grade 100 capacities.



Trade Size	Article-No.	Working Load Limit [t]	Dimensions [mm]							Weight app. [kgs]
			d ₁ ¹⁾	d ₂	e	c	g	h	f	
6-10*	F32353	1,40	21 ¹⁾	12	108	20	50	24	-	0,44
7/8-10*	F32363	2,50	28 ¹⁾	14	135	26	66	33	-	0,97
10-10*	F32373	4,00	32 ¹⁾	18	161	32,5	76	35	-	1,56
13-10*	F32383	6,70	42 ¹⁾	21	196	38	89	42	-	2,96
16-10*	F32395	10,00	54 ¹⁾	23	229	45	102	48	-	4,71
18/20-10	F32405	16,00	59	27	259	58,5	114	63	70	7,95
22-10	F32413	19,00	65	30	288	65	127	70	78	10,88
26-10*	F32423	26,50	76	35	329	75	136	81	89	16,49
32-10*	F32443	40,00	85	42	358	83	152	97	100	26,20

*On request

¹⁾ With circular eyelet

TWN 1856

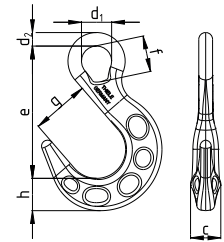

Clevis Skip Suspension Hooks NEW

The grade 100 skip suspension hooks TWN 1899 connect chain slings with the pivot of containers, e.g. containers according to the DIN 30720. The shape of the hook opening is designed to fit container lifting pivots. The clevis design enables the direct attachment to the chain. The hooks lock automatically when under load and may only be reopened manually if not under load anymore. The skip suspension hooks comply with the DIN EN 1677-3, under consideration of grade 100 working load capacities.



Trade Size	Article-No.	Working Load Limit [t]	Dimensions [mm]								Weight app. [kgs]
			e	c	g	h	d	b	a	l	
13-10	F335100	6,70	166	40	51	42	37	64	135	239	3,34

TWN 1899

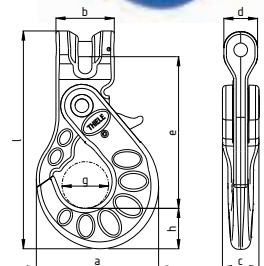



Hooks/ Shortening Components

TWN 1869

Clevis Skip Suspension Links for One-Hand Operation and Forged Safety Latch **NEW**



The grade 100 skip suspension links TWN 1869 connect chain slings with the pivots on containers, e.g. containers according to the DIN EN 30720. The shape of the eyelet is designed to fit container suspension pivots. The clevis design enables the direct attachment to the chain. The forged safety latch enables a one-hand operation. The manufacturing and testing requirements are based on DIN EN 1677-1, under consideration of grade 100 load capacities.

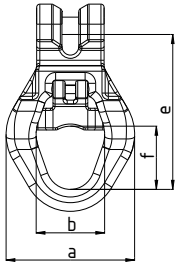

Trade Size	Article-No.	Working Load Limit [t]	Dimensions [mm]				Weight app. [kgs]
			e	f	b	a	
13-10	F313805	6,7	142	57,5	65	122	1,94

TWN 0869/1

Container Pivots

The container pivots TWN 0869/1 are welded to containers and serve as lifting points for attaching skip suspension hooks and links.

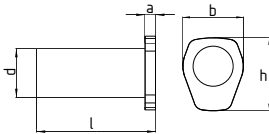

Article-No.	Dimensions [mm]					Weight app. [kgs]
	a	d	b	l	h	
F31410	10	45	68	110	82	1,60



Shortening Components

Clevis Shortening Hooks

The grade 100 clevis shortening hooks TWN 1827 are used to adjust the strand lengths of chain slings and lashing chains. The clevis design enables the direct attachment to the chain. The manufacturing and testing requirements comply with the DIN EN 1677-1 and DIN 5692, under consideration of grade 100 load capacities. The shortening hook has been tested in combination with the lifting chain. The extra wide chain support ensures a particularly firm fit of the inserted chain link. At the same time the link is protected from getting damaged.



Trade Size	Article-No.	Working Load Limit [t]	Dimensions [mm]				Weight app. [kgs]
			e	g	l	b	
7-10*	F33203	1,90	68,5	8,5	102,5	54	0,50
8-10	NEW F33204	2,50	71	9,5	110	56	0,53
10-10	F33214	4,00	83	12,5	132	67	0,93
13-10	F33224	6,70	109	15,5	168	83	1,99
16-10	F33234	10,00	137	18,5	208	101	3,62
20-10*	NEW F33236	16,00	170	23,5	260	127	7,38
22-10*	NEW F33238	19,00	186	25,5	286	139	9,95
26-10*	NEW F33242	26,50	220	30	337	164	15,26
32-10*	NEW F33244	40,00	271	37	415	202	28,18

*On request

TWN 1827

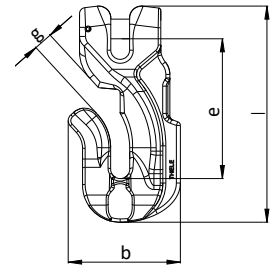

Clevis Shortening Hooks with Safety Pin

The grade 100 clevis shortening hooks with safety pin TWN 1827/1 are used to adjust the strand lengths of chain slings and lashing chains. The clevis design enables the direct attachment to the chain. The safety pin prevents the chain strand from accidental release. The manufacturing and testing requirements comply with the DIN EN 1677-1 and DIN 5692, under consideration of grade 100 load capacities. The shortening hook has been tested in combination with the lifting chain. The extra wide chain support ensures a particularly firm fit for the inserted chain link. At the same time the link is protected from getting damaged. The safety bolt enables the use in lashing chains according to the DIN EN 12195-3.



NEW:
Application and assembly video for the shortening hook with safety pin on YouTube!

Trade Size	Article-No.	Working Load Limit [t]	Dimensions [mm]				Weight app. [kgs]
			e	g	l	b	
7-10*	NEW F332022	1,90	68,3	8,5	102,5	54	0,50
8-10	NEW F33205	2,50	71	9,5	110	56	0,54
10-10	F33215	4,00	82,7	12,5	132	67	0,94
13-10	F33225	6,70	109	15,5	168	83	2,00
16-10	F33235	10,00	137	18,5	208	101	3,64
20-10*	NEW F33237	16,00	170	23,5	260	127	7,42
22-10*	NEW F33239	19,00	186	25,5	286	139	10,00
26-10*	NEW F33243	26,50	220	30	337	164	15,37
32-10*	NEW F33247	40,00	271	37	415	200	28,29

*On request

TWN 1827/1

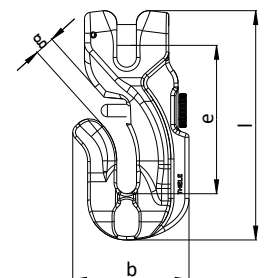



Shortening Components

TWN 1851/1

Clevis Shortening Claws with Safety Pin NEW



The grade 100 clevis shortening claws with safety pin TWN 1851/1 are used to adjust the strand lengths of chain slings and lashing chains. The clevis design enables the direct attachment to the chain. The safety pin prevents the chain strand from accidental release. The manufacturing and testing requirements comply with the DIN EN 1677-1 and the DIN 5692, under consideration of grade 100 load capacities. The shortening claws have been tested in interaction with the lifting chain. The chain pockets ensure a particularly tight fit for the inserted chain link. The safety bolt enables the use in lashing chains according to DIN EN 12195-3.

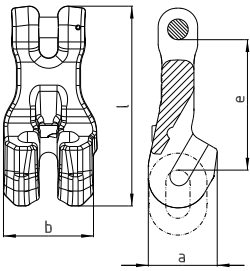

Trade Size	Article-No.	Working Load Limit [t]	Dimensions [mm]				Weight app. [kgs]
			e	a	b	l	
6-10	F349141	1,40	51	27	37	78	0,25
8-10	F349241	2,50	65	34	46	100	0,50
10-10	F349341	4,00	81	43	56	124	0,94
13-10	F349441	6,70	106	56	73	162	2,03
16-10	F349551	10,00	130	68	88	198	3,61
20-10	F349661	16,00	161	85	109	246	7,08
22-10	F349771	19,00	177	94	120	271	9,52
26-10*	F349881	26,50	196	109	135	307	13,20
32-10*	F349991	40,00	240	135	166	370	24,50

*On request

TWN 1852

RAPID® Shortening Claws



The grade 100 RAPID® shortening claws TWN 1852 are used to adjust the strand lengths of chain slings and lashing chains. Due to the double claws, the RAPID® shortening claws can be universally integrated to existing chain strands without permanently mounting them into the chain sling. The manufacturing and testing requirements comply with the DIN EN 1677-1 and DIN 5692, under consideration of grade 100 load capacities. The shortening claws have been tested in interaction with the sling chains. The chain pockets ensure a tight fit of the inserted chain link.

The safety bolt enables the use in lashing chains according to the DIN EN 12195-3. RAPID® shortening claws can be installed quickly and subsequently in chain sling and lashing chains without tools.

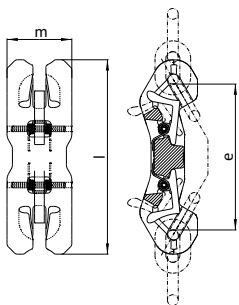

Trade Size	Article-No.	Working Load Limit [t]	Dimensions [mm]			Weight app. [kgs]
			e	l	m	
8-10	F34775	2,50	111	148	48	1,11
10-10	F34780	4,00	134	180	60	2,09
13-10	F34785	6,70	179	240	78	4,76
16-10	F34790	10,00	224	296	96	9,07

Shortening Components/ Shackles

Shortening Devices for Fixed Size Master Links

The grade 100 shortening devices for fixed size master links TWN 1896 are used in chain slings and enable the strand lengths to be adapted to the conditions of use. The manufacturing and testing requirements are based on the DIN EN 818-4, DIN EN 1677 parts 1 and 4 and the DIN 5688-3, under consideration of grade 100 load capacities.



Trade Size	Article-No.	Working Load Limit [t]	Dimensions [mm]						Weight app. [kgs]
			e	e ₁	e ₂	B-Link			
						d	t	b	
6-10	F189606	1,40	137	31	60	10	46	23	0,32
8-10	F189608	2,50	175	38	78	13	60	30	0,70
10-10	F189610	4,00	215	46	99	16	70	35	1,40
13-10	F189613	6,70	270	59	126	18	85	40	2,60
16-10	F189616	10,00	326	76	150	22	100	50	5,00

TWN 1896

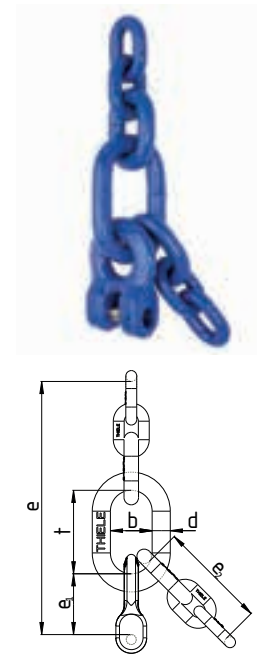

Shackles

Bolt Shackles Type C with Nut and Roll Pin

The grade 100 shackles type C with bolt, nut and roll pin TWN 1871 are used as end fittings in chain slings. The type C shackles can also be mounted directly on shackles and traverses. The dimensions of the type C shackles comply with the DIN 82101. The manufacturing and testing requirements are based on the DIN EN 1677-1, under consideration of grade 100 load capacities.



Trade Size	Article-No.	Working Load Limit [t]	Dimensions [mm]						Weight app. [kgs]
			d ₁	d ₂	d ₄	b ₁	b ₂	h ₁	
6-10*	NEW F303000	1,40	9	20	13	13	28	28	0,32
8-10*	NEW F303005	2,50	12	26	14	17	38	38	0,40
10-10	F303100	4,00	15	32	16	21	47	49	0,45
13-10	F303200	6,70	19	40	20	28	62	61	0,84
16-10	F303300	10,00	23	48	24	33	75	73	1,49
20-10*	NEW F303400	16,00	30	64	30	42	95	91	3,20
22-10	F303500	19,00	33	72	36	47	107	111	4,59

TWN 1871

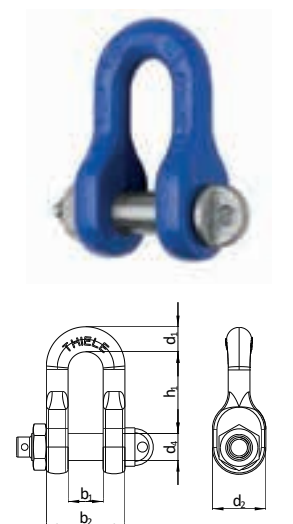

*On request



Chain Tensioners/ Special Sling Components

TWN 1454

Chain Tensioners with Toggle (Large Lift)



The grade 100 chain tensioners with toggle TWN 1454 are used as tensioning elements in lashing chains. The chain tensioners can also be used in chain slings for stepless adjustment of strand lengths when lifting loads. These chain tensioners have a particularly large lift. The chain tensioners with toggle and trapezoidal thread achieve a high pretensioning force with little force impact. This property is of fundamental importance when lashing down, as the level of the pretensioning force contributes to load securing. The manufacturing and testing requirements are based on DIN EN 1677-1, under consideration of grade 100 forces.

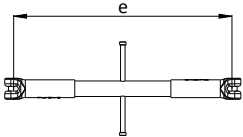

Trade Size	Article-No.	Working Load Limit [t]	Normal straight load [daN]	Lashing Capacity (LC) [daN]	Dimensions [inch]			Weight app. [kgs]
					e _{max}	e _{min}	lift	
13-10	F341877	6,70	2.600	13.000	675	445	230	7,19
16-10	F341977	10,00	3.100	20.000	830	550	280	11,80

If the products are initially used for lifting, e.g. internal transport, up to the load capacity, they can still be used as lashing products. If lifting products are used for lashing, they may no longer be used for lifting anymore!

TWN 1455

Chain Tensioners with Ratchet (Large Lift)



The grade 100 chain tensioners with ratchet TWN 1455 are used as tensioning elements in lashing chains. The chain tensioners can also be used in chain slings for stepless adjustment of strand lengths when lifting loads. The chain tensioners have a particularly large lift. The chain tensioners with ratchet and trapezoidal thread achieve a high pretensioning force with little force impact. This property is of fundamental importance when lashing down, as the level of the pretensioning force contributes to load securing. The manufacturing and testing requirements are based on DIN EN 1677-1, under consideration of grade 100 forces.

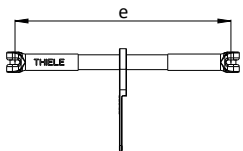

Trade Size	Article-No.	Working Load Limit [t]	Normal straight load [daN]	Lashing Capacity (LC) [daN]	Dimensions [inch]			Weight app. [kgs]
					e _{max}	e _{min}	lift	
13-10	F341878	6,70	2.600	13.000	675	445	230	8,40

If the products are initially used for lifting, e.g. internal transport, up to the load capacity, they can still be used as lashing products. If lifting products are used for lashing, they may no longer be used for lifting anymore!

Special Sling Components

TWN 1812

Ring Shackles



The grade 100 ring shackles TWN 1812 are used to connect chains to sling components to assemble chain slings. The manufacturing and testing requirements are based on DIN EN 1677-1, under consideration of grade 100 load capacities.

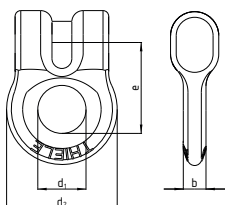

Trade Size	Article-No.	Working Load Limit [t]	Dimensions [mm]				Weight app. [kgs]
			e	d ₁	d ₂	b	
6-10	F31704	1,40	31	17	39	8	0,10
8-10	F31714	2,50	37	21	50	11	0,23
10-10	F31724	4,00	46	26	62	14	0,48
13-10	F31734	6,70	59	33	79	18	0,85
16-10	F31744	10,00	76	42	100	23	1,59
22-10	NEW F31764	19,00	100	57	135	30,5	3,93

Special Sling Components/ Lashing Chains

Swivel Adapters NEW

The grade 100 swivel adapters with ball-bearing TWN 1846 supplement components with clevis design and align the individual suspension strands without twisting. The swivel adapter is fixed to the clevis design of the end link, e.g. a sling hook. The large eyelet enables e.g. a connection to chain or rope strands as well as textile slings. The manufacturing and testing requirements comply with the DIN EN 1677-1, under consideration of grade 100 load capacities.



Trade Size	Article-No.	Working Load Limit [t]	Dimensions [mm]								Weight app. [kgs]
			e	d ₁	d ₂	d ₃	b	c	a	f	
8-10*	F32820	2,50	94	45	16	16	77	52	117	8,5	0,74
10-10	F32825	4,00	97	45	16	16	77	52	124	11	0,79
13-10*	F32830	6,70	117	50	20	20	90	59	151	14	1,43
16-10*	F32835	10,00	146	65	25	25	115	73	189	17	2,72

*On request

TWN 1846

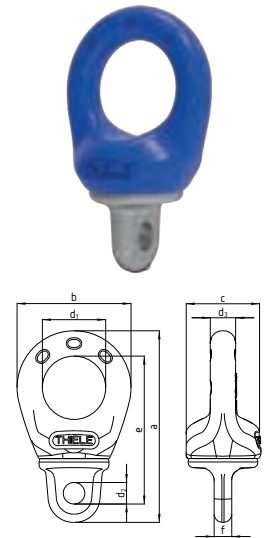

Lashing Chains

Lashing Chains with Tensioner

The grade 100 lashing chains with toggle and adjustable lashing chain TWN 1410 have a standard length of 3,5 m and are used for heavy-duty lashing applications. The chain tensioners with toggle and trapezoidal thread achieve a high pretensioning force with little force impact. This property is of fundamental importance when lashing down, as the level of the pretensioning force contributes to load securing. The manufacturing and testing requirements are based on the DIN EN 12195-3, under consideration of grade 100 lashing forces.



Trade Size	Article-No.	Lashing Capacity (LC) [daN]	Weight app. [kgs]
13-10	F34183	13.000	28,39
16-10	F34184	20.000	46,43

Other lengths available on request.

TWN 1410



Lashing Chains with Ratchet

The grade 100 lashing chains with ratchet and shortenable lashing chain TWN 1411 have a standard length of 3,5 m and are used in the heavy-duty area for lashing loads in road traffic. The chain tensioners with ratchet and trapezoidal thread achieves a high pretensioning force with little force impact. This property is of fundamental importance when lashing down, as the level of the pretensioning force contributes to load securing. The manufacturing and testing requirements are based on the DIN EN 12195-3, under consideration of grade 100 lashing forces.



Trade Size	Article-No.	Lashing Capacity (LC) [daN]	Weight app. [kgs]
13-10	F34183R	13.000	21,00

Other lengths available on request.

TWN 1411





TWN 0944

Chain File



The chain file TWN 0944 is used for documentation of chain inspections.

Trade Size	Article-No.	Packing Units	Weight app. [kgs]
-	Z04575	1 pc.	0,01

TWN 0945

Assembly Kit



The assembly kit TWN 0945 is used for easy disassembly of bolts and dowel pins of clevis connections.

Trade Size	Article-No.	Packing Units	Weight app. [kgs]
-	Z03303	1 set	0,60

TWN 0968

Spare Part Sets for Skip Suspension Hooks and Links NEW



The spare part sets TWN 0968 consist of bolt, roll pins and are suitable for the clevis connections of the skip suspension hooks TWN 1399 and TWN 1899 and skip suspension links TWN 0869 and TWN 1869.

Trade Size	Article-No.	Packing Units	Weight app. [kgs]
13-10	F486741	1 set	0,09

TWN 0969

Spare Part Sets for Skip Suspension Links



The spare part sets TWN 0969 consist of a forged safety latch, spring and dowel pins and are suitable for the TWN 0869 and TWN 1869.

Trade Size	Article-No.	Packing Units	Weight app. [kgs]
13-10 (G100 G80)	F314081	1 set	0,20

Spare Parts and Accessoires

Spare Part Sets for Skip Suspension Hooks **NEW**

The spare part sets TWN 0970 consist of a retainer, spring and dowel pin and are suitable for skip suspension hooks TWN 1399 and TWN 1899.

Trade Size	Article-No.	Packing Units	Weight app. [kgs]
13-10/16-10 (G100 G80)	F48332	1 set	0,11



Spare Part Sets for Clevis Shortening Claws **NEW**

The spare part sets TWN 0971 consist of a locking pin, a threaded pin, spring and bearing and are suitable for the clevis shortening hooks with safety pin TWN 0851/1 and TWN 1851/1.

Trade Size	Article-No.	Packing Units	Weight app. [kgs]
6-10 (G100 G80)	F483110	1 set	0,01
8-10 (G100 G80)	F483112	1 set	0,01
10-10 (G100 G80)	F483113	1 set	0,02
13-10 (G100 G80)	F483114	1 set	0,03
16-10 (G100 G80)	F483115	1 set	0,05
20-10 (G100 G80)	F483117	1 set	0,07
22-10 (G100 G80)	F483118	1 set	0,09
26-10 (G100 G80)	F483119	1 set	0,12
32-10 (G100 G80)	F483120	1 set	0,17

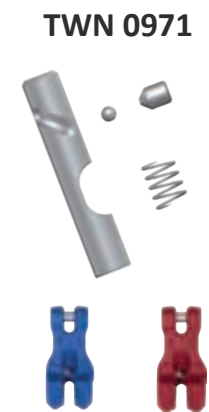

Identification Tag for Lashing Chains

The identification tags TWN 1402 are used to identify lashing chains and provide important information for safe operation. Lashing chains and chain slings may not be operated without identification tags.

Article-No.	Packing Units	Weight app. [kgs]
Z07264	1 pc.	0,05

TWN 1402



Spare Part Sets for Clevis Design

The spare part sets TWN 1904/0 consist of a bolt and dowel pin and are suitable for THIELE products with the grade 100 fixed size clevis design.

Trade Size	Article-No.	Packing Units	Weight app. [kgs]
6-10	F48686	1 set	0,02
7-10 NEW	F486861	1 set	0,03
8-10	F48687	1 set	0,03
10-10	F48688	1 set	0,05
13-10	F48689	1 set	0,10
16-10	F48690	1 set	0,16
20-10 NEW	F48692	1 set	0,28
22-10 NEW	F48693	1 set	0,37
26-10 NEW	F486931	1 set	0,57
32-10 NEW	F486933	1 set	1,04

TWN 1904/0





TWN 1908/0

Spare Part Sets for Hooks

The spare part sets TWN 1908/0 consist of a safety latch, spring and 2 dowel pins and are suitable for grade 100 sling hooks TWN 1835/1, TWN 1840/1, TWN 1841/1 and also fit the grade 80 sling hooks TWN 0835/1, TWN 0850/1, TWN 1340/1 and TWN 0858/1.



Trade Size	Article-No.	Packing Units	Weight app. [kgs]
6-10	F48731	1 set	0,05
7/8-10	NEW F48733	1 set	0,08
10-10	F48735	1 set	0,14
13-10	F48737	1 set	0,31
16-10	F48739	1 set	0,38
20-10	F48743	1 set	0,71
22-10	F48745	1 set	0,89
26-10	F48748	1 set	1,41
32-10	NEW F48749	1 set	1,77

TWN 1921

Spare Part Sets for XL-LOK Connectors

The spare part sets TWN 1921 consist of a bolt and clamping bush and are suitable for XL-LOK TWN 1820 connecting links.



Trade Size	Article-No.	Packing Units	Weight app. [kgs]
6-10	F486013	1 set	0,01
8-10	F486043	1 set	0,02
10-10	F486073	1 set	0,04
13-10	F486103	1 set	0,06
16-10	F486133	1 set	0,12
22-10	F486191	1 set	0,46

TWN 1922

Spare Part Sets for XL-LOK Connectors **NEW**

The spare part sets TWN 1922 consist of a bolt and clamping bush and are suitable for XL-LOK TWN 1820 connecting links.



Trade Size	Article-No.	Packing Units	Weight app. [kgs]
20-10	F486105	1 set	0,25
22-10	F486106	1 set	0,32
26-10	F486107	1 set	0,55
32-10	F486108	1 set	0,99

TWN 1930/0

Spare Part Sets for Shackles Type C

The spare part sets TWN 1930/0 consist of a head bolt, nut and splint and are suitable for grade 100 shackles type C TWN 1871.



Trade Size	Article-No.	Packing Units	Weight app. [kgs]
6-10	NEW F304310	1 set	0,03
8-10	NEW F304410	1 set	0,08
10-10	F304510	1 set	0,13
13-10	F304610	1 set	0,25
16-10	F304710	1 set	0,47
20-10	NEW F304810	1 set	1,12
22-10	NEW F304910	1 set	1,31

Spare Parts and Accessoires

Spare Part Sets for RAPID®-Shortening Claws

The trigger sets TWN 1931/0 consist of 2 retainers, springs and roll pins and are suitable for grade 100 RAPID® shortening claws TWN 1852.

Trade Size	Article-No.	Packing Units	Weight app. [kgs]
8-10	F347750	1 set	0,02
10-10	F347800	1 set	0,09
13-10	F347850	1 set	0,09
16-10	F347900	1 set	0,17

TWN 1931/0



Spare Part Sets for Clevis Self-Locking Hooks NEW

The spare part sets TWN 1933/0 consist of a bolt and a roll pin and are suitable for grade 100 self-locking hooks with clevis design TWN 1837.

Trade Size	Article-No.	Packing Units	Weight app. [kgs]
6-10	F487800	1 set	0,01
7-10	F487801	1 set	0,01
8-10	F487802	1 set	0,02
10-10	F487803	1 set	0,04
13-10	F487804	1 set	0,08
16-10	F487805	1 set	0,16
20-10	F487806	1 set	0,31
22-10	F487807	1 set	0,46

TWN 1933/0



Spare Part Sets for Clevis Self-Locking Hooks

The spare part sets TWN 1933/0A consist of a bolt and 2 roll pins and are suitable for grade 100 self-locking hooks with clevis design TWN 1837A.

Trade Size	Article-No.	Packing Units	Weight app. [kgs]
6-10	Z10118	1 set	0,01
8-10	Z10119	1 set	0,02
10-10	Z10120	1 set	0,04
13-10	Z10121	1 set	0,08
16-10	Z10122	1 set	0,15
22-10	Z10125	1 set	0,46

TWN 1933/0A



Spare Part Sets for Self Locking Hooks NEW

The trigger sets TWN 1935 consist of a retainer, spring and dowel pin. The trigger sets are suitable for grade 100 self-locking hooks TWN 1836, TWN 1837 and TWN 1838.

Trade Size	Article-No.	Packing Units	Weight app. [kgs]
6-10	F487810	1 set	0,02
7-10	F487811	1 set	0,02
8-10	F487812	1 set	0,04
10-10	F487813	1 set	0,05
13-10	F487814	1 set	0,18
16-10	F487815	1 set	0,19
20-10	F487816	1 set	0,23
22-10	F487817	1 set	0,25

TWN 1935





TWN 1935A

Spare Part Sets for Self Locking Hooks



The trigger sets TWN 1935A consist of a retainer, spring and dowel pin. The trigger sets are suitable for grade 100 self-locking hooks TWN 1836A and TWN 1837A.

Trade Size	Article-No.	Packing Units	Weight app. [kgs]
6-10	Z10110	1 set	0,02
8-10	Z10111	1 set	0,03
10-10	Z10112	1 set	0,04
13-10	Z10113	1 set	0,06
16-10	Z10114	1 set	0,11
22-10	Z10117	1 set	0,25

TWN 1940

Identification Tags for single- and multi-leg Chain Slings



The grade 100 identification tags TWN 1940 are used to identify chain slings and provide important information for the operator. Chain slings may not be used without an identification tag.

Article-No.	Execution	Weight app. [kgs]
F08052	without welded ring	0,11
F08053	with welded ring	0,11

TWN 1946

Chain Gauges



The chain measuring gauges TWN 1946 are used to measure the discard criteria of grade 100 lifting chains XL400 and XL200.

Trade Size	Article-No.	Packing Units	Weight app. [kgs]
6-10	F01690	1 pc.	0,07
8-10	F01691	1 pc.	0,07
10-10	F01692	1 pc.	0,09
13-10	F01693	1 pc.	0,11
16-10	F01694	1 pc.	0,14

TWN 1950

Spare Part Sets for Shortening Hooks



The spare part sets TWN 1950 consist of locking pin, spring and knurled nut and are suitable for grade 100 shortening hooks TWN 1827/1.

Trade Size	Article-No.	Packing Units	Weight app. [kgs]
7/8-10	F48330	1 set	0,02
10-10	F48328	1 set	0,04
13-10	F483290	1 set	0,04
16-10	F48339	1 set	0,06
20-10	NEW F48340	1 set	0,11
22-10	NEW F48341	1 set	0,12
26-10	NEW F48343	1 set	0,29
32-10	NEW F48344	1 set	0,34

Examples for Chain Slings





1-leg Chain Slings with XL-LOK Connection

TWN 1600	TWN 1601	TWN 1602	TWN 1603
			
TWN 1604			
			



TA10

2-leg Chain Slings with XL-LOK Connection

TWN 1650	TWN 1651	TWN 1652	TWN 1653
			
TWN 1654			
			



Examples for Chain Slings

4-leg Chain Slings with XL-LOK Connection

TWN 1750	TWN 1751	TWN 1752	TWN 1753
TWN 1754			

1-leg Chain Slings, Fixed Size

2-leg Chain Slings, Fixed Size

TWN 1631	TWN 1632	TWN 1681	TWN 1682

4-leg Chain Slings, Fixed Size

TWN 1781	TWN 1782

Shortening Options

With Shortening Claws TWN 1851, TWN 1851/1 und TWN 1896



With RAPID®-Shortening Claws TWN 1852



With Shortening Claws TWN 1851, TWN 1851/1 und TWN 1896



Type K11



Circumference $\approx 2 \times$ Reach

Type K12

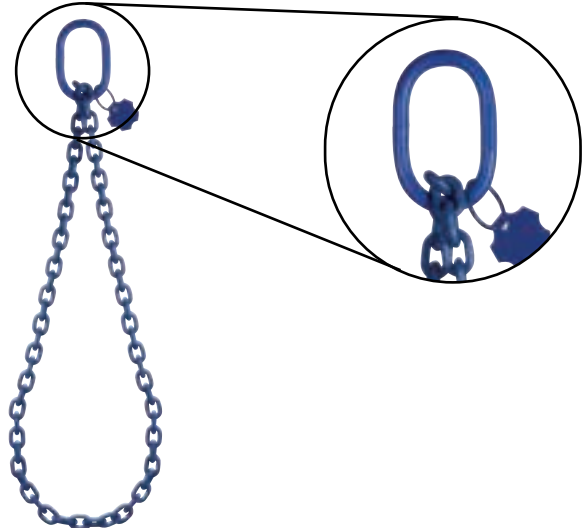

Type K22

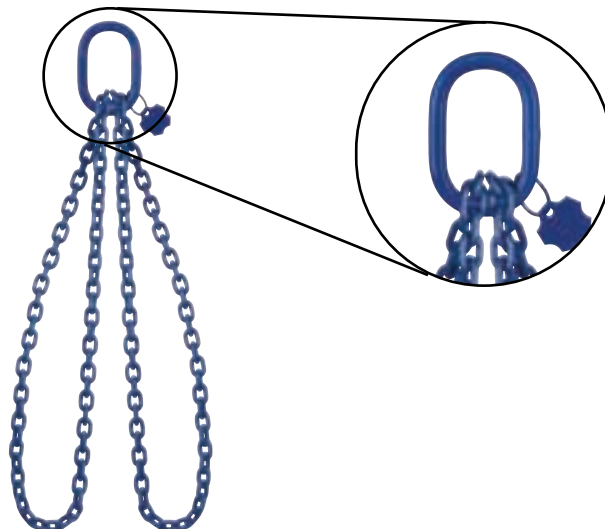



THIELE®



TA8



THIELE
LIFTING PRODUCTS

Grade 80



Page
63

Round Steel Chains

TWN 0805



Pages
64-70

Suspension Components

TWN 0795



TWN 0810/1



TWN 0810/2



TWN 0810/4



TWN 0811/1



TWN 0811/2



TWN 0811/4



TWN 0815



TWN 0816



TWN 0817



TWN 0820



TWN 1313



TWN 1314



TWN 1315



Page
70

Connectors

TWN 1320



Pages 71-76	Hooks				
TWN 0798 	TWN 0799 	TWN 0854 	TWN 0855 	TWN 0855/1 	
TWN 0856 	TWN 0856/1 	TWN 0858/1 	TWN 0859 	TWN 0860 	
TWN 0868 	TWN 0872 	TWN 0873 	TWN 0889 	TWN 1340/1 	
TWN 1399 	TWN 0869 	TWN 0869/1 			

Pages 77-78	Shortening Components				
TWN 0827 	TWN 0827/1 	TWN 0851 	TWN 0851/1 	TWN 0896 	

Pages 79-80	Shackles				
TWN 0861 	TWN 0862 	TWN 0870 	TWN 0871 	TWN 0897 	





Product Overview - Lifting Products Grade 80

Pages
80-81

Chain Tensioners

TWN 1450



TWN 1451



TWN 1452



Pages
81-83

Special Sling Components

TWN 0812



TWN 0845



TWN 0882



TWN 0892



TWN 0893



TWN 0894



TWN 0601



Page
84

Lashing Chains



TWN 1400





TWN 1401



Pages 85-90	Spare Parts and Accessoires				
	TWN 0904/0	TWN 0905/0906	TWN 0920-0922	TWN 0930	TWN 0940
					
	TWN 0944	TWN 0945	TWN 0946	TWN 0950-0952	TWN 0962
					
TWN 0967/0	TWN 0967/1	TWN 0968	TWN 0969	TWN 0970	
					
TWN 0971	TWN 1402	TWN 1908/0	TWN 1920		
					

Page 91	Chain Slings				
	TWN 0449	TWN 0536	TWN 0710/1		
					

Page 92	Endless Chains				
	Type K11	Type K12	Type K22		
					

1. Determine the weight of the load to be lifted.

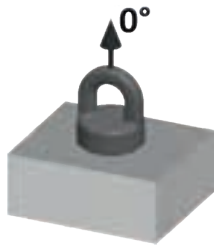

5. Consider that asymmetry may influence the load factor (see table 4 on page 63).

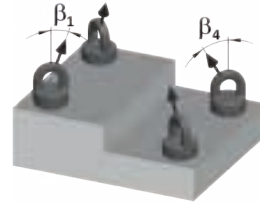

2. Check number of chain strands required (depending on the number of available lifting points).

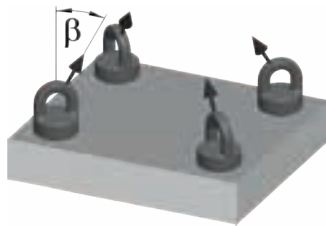

6. Specify the sling using components for the selected chain trade size.



3. Determine the trade size by taking the inclination angle into consideration (see table 1 on page 60 and table 2 on page 61 and table 3 on page 62).

7. Determine the chain length for each strand by considering the required effective reaches.

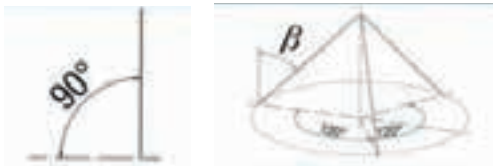

4. Consider possible temperature impacts (see load reductions on page 63).

8. Control selected lifting components and/ or chain slings to ensure that they meet applicable safety-laws and regulations (e.g. DGUV)



Special Advices:

Please also consider special conditions of use, such as e.g. intermittent impacts on loads when selecting the grade 80 chain slings. If the chain slings were used above the maximum admissible temperature, they have to be immediately rejected. The THIELE-assembly systems must not be used with chemical influences such as acids and/or lyes.

Lifting products according to DIN EN 818-4 fulfill the requirements of the EC-directive for machines, especially for safety relevant components. The working load limit and the test requirements meet or exceed the European standards.

Identification Tags

The use of chain slings without identification tag is not permitted. The data on the identification tag must be in accordance with the standard DIN EN 818-4 for chain slings.

THIELE Grade 80 identification tags have an octagonal shape for easy identification.

Legal Marking of Grade 80 Chains according to the German DGUV

The number "4" below the  is the registration number of the German Statutory Accident Insurance (DGUV) and identifies the manufacturer of the sling. The marking is recognized by all international certification societies and work authorities.

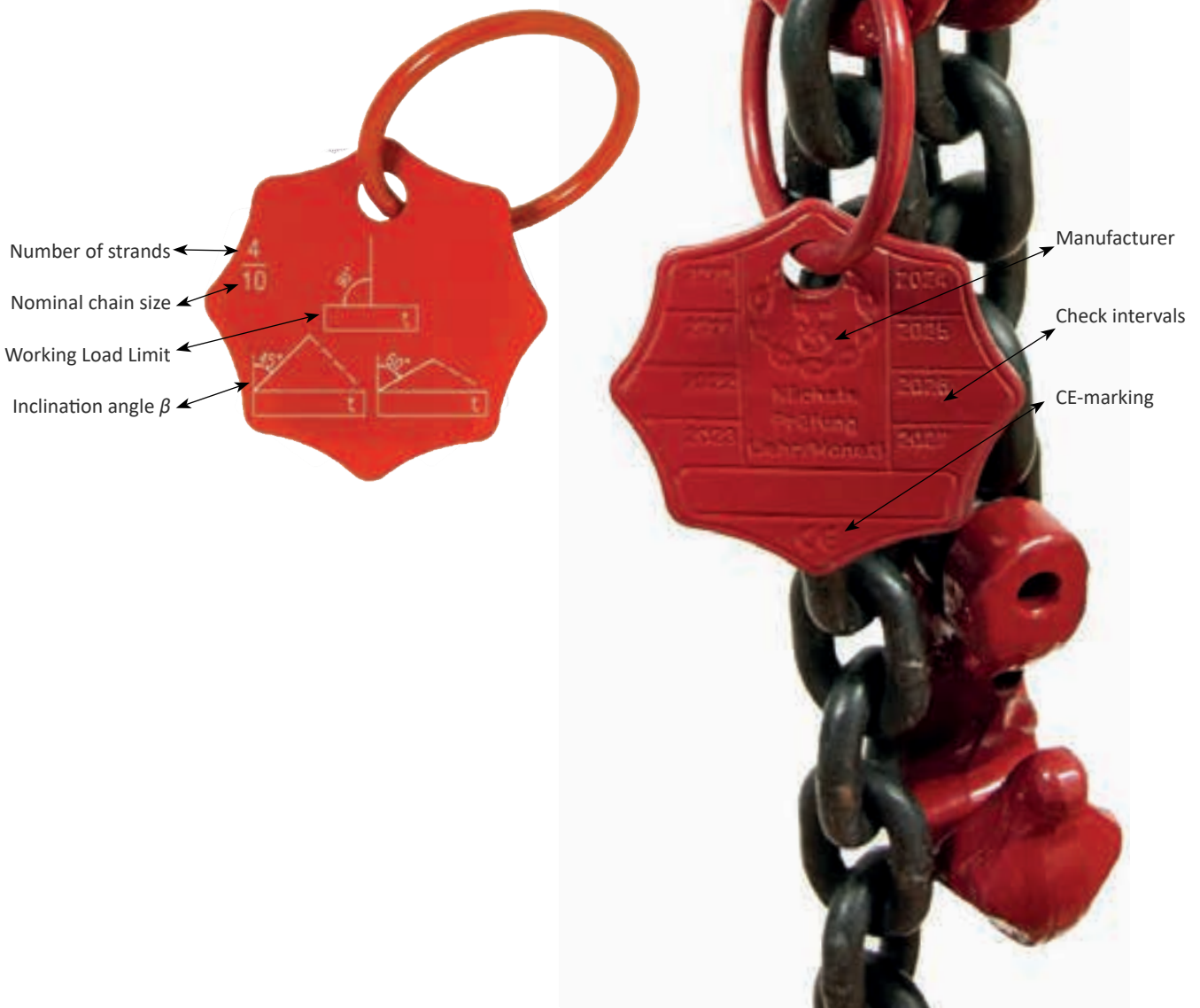

Working Load Limit – Type: Direct (Chain Slings)

		1-leg	2-leg		3-/ 4-leg	
Inclination Angle		$\beta = 0^\circ$	$0^\circ < \beta \leq 45^\circ$	$45^\circ < \beta \leq 60^\circ$	$0^\circ < \beta \leq 45^\circ$	$45^\circ < \beta \leq 60^\circ$
Load Factor		1	1,4	1	2,1	1,5
Trade Size	Nominal Size [mm]	[t]	[t]	[t]	[t]	[t]
6-8	6	1,12	1,60	1,12	2,36	1,70
7-8	7	1,50	2,12	1,50	3,15	2,24
8-8	8	2,00	2,80	2,00	4,25	3,00
10-8	10	3,15	4,25	3,15	6,70	4,75
13-8	13	5,30	7,50	5,30	11,20	8,00
16-8	16	8,00	11,20	8,00	17,00	11,80
18-8	18	10,00	14,00	10,00	21,20	15,00
20-8	20	12,50	17,00	12,50	26,50	19,00
22-8	22	15,00	21,20	15,00	31,50	22,40
26-8	26	21,20	30,00	21,20	45,00	31,50
28-8*	28	25,00	33,50	25,00	50,00	37,50
32-8	32	31,50	45,00	31,50	67,00	47,50
36-8	36	40,00	56,00	40,00	85,00	60,00
40-8	40	50,00	71,00	50,00	106,00	75,00
45-8*	45	63,00	90,00	63,00	132,00	95,00
50-8*	50	80,00	112,00	80,00	160,00	118,00
56-8*	56	100,00	140,00	100,00	200,00	150,00
63-8*	63	125,00	170,00	125,00	265,00	190,00
71-8*	71	160,00	224,00	160,00	335,00	236,00

THIELE chain slings are available in mounted and welded execution.

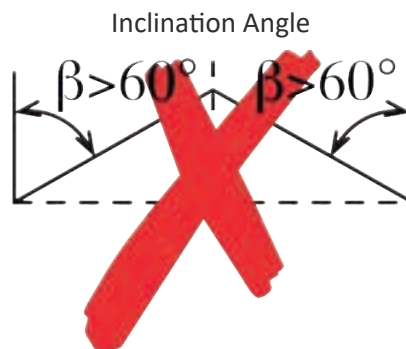

*These trade sizes are available in welded execution only.

Table 1



Working Load Limit Tables

Working Load Limit – Type: Choke Hitch (Chain Slings)

		1-leg	2-leg	
				
Inclination Angle		$\beta = 0^\circ$	$0^\circ < \beta \leq 45^\circ$	$45^\circ < \beta \leq 60^\circ$
Load Factor		0,8	1,12	0,8
Trade Size	Nominal Size [mm]	[t]	[t]	[t]
6-8	6	0,90	1,25	0,90
7-8	7	1,25	1,70	1,25
8-8	8	1,60	2,24	1,60
10-8	10	2,50	3,55	2,50
13-8	13	4,25	6,00	4,25
16-8	16	6,30	9,00	6,30
18-8	18	8,00	11,20	8,00
20-8	20	10,00	14,00	10,00
22-8	22	11,80	17,00	11,80
26-8	26	17,00	23,60	17,00
28-8*	28	20,00	28,00	20,00
32-8	32	25,00	35,50	25,00
36-8	36	31,50	45,00	31,50
40-8	40	40,00	56,00	40,00
45-8*	45	50,00	71,00	50,00
50-8*	50	63,00	90,00	63,00
56-8*	56	80,00	112,00	80,00
63-8*	63	100,00	140,00	100,00
71-8*	71	125,00	180,00	125,00

THIELE chain slings are available in mounted and welded execution.

*These trade sizes are available in welded execution only.

Table 2



Working Load Limit – Type: Choke Hitch (Endless Chains)

		K11		K12/K13		K22/K23	
Inclination Angle		$\beta = 0^\circ$	$0^\circ < \beta \leq 25^\circ$	$0^\circ < \beta \leq 45^\circ$	$45^\circ < \beta \leq 60^\circ$	$0^\circ < \beta \leq 45^\circ$	$45^\circ < \beta < 60^\circ$
Load Factor		1,6	1,45	1,12	0,8	1,7	1,2
Trade Size	Nominal Size [mm]	[t]	[t]	[t]	[t]	[t]	[t]
6-8	6	1,80	1,60	1,25	0,90	1,90	1,32
7-8	7	2,50	2,24	1,70	1,25	2,65	1,80
8-8	8	3,15	2,80	2,24	1,60	3,35	2,36
10-8	10	5,00	4,50	3,55	2,50	5,30	3,75
13-8	13	8,50	7,50	6,00	4,25	9,00	6,30
16-8	16	12,50	11,80	9,00	6,30	13,20	9,50
18-8	18	16,00	15,00	11,20	8,00	17,00	11,80
20-8	20	20,00	18,00	14,00	10,00	21,20	15,00
22-8	22	23,60	22,40	17,00	11,80	25,00	18,00
26-8	26	33,50	30,00	23,60	17,00	35,50	25,00
28-8*	28	40,00	35,50	28,00	20,00	42,50	30,00
32-8	32	50,00	47,50	35,50	25,00	53,00	37,50
36-8	36	63,00	60,00	45,00	31,50	67,00	47,50
40-8	40	80,00	71,00	56,00	40,00	85,00	60,00
45-8*	45	100,00	90,00	71,00	50,00	106,00	75,00
50-8*	50	125,00	112,00	90,00	63,00	132,00	95,00
56-8*	56	160,00	140,00	112,00	80,00	170,00	118,00
63-8*	63	200,00	180,00	140,00	100,00	212,00	150,00
71-8*	71	250,00	224,00	180,00	125,00	265,00	190,00

THIELE chain slings are available in mounted and welded execution.
 *These trade sizes are available in welded execution only.

Table 3



Type K11



Type K12



Type K22

Load Reductions/ Lifting Chains

Temperature Application Range of Grade 80 Lifting Chains acc. to the DIN EN 818-2

Temperature Application Range	Working Load Limit
-40°C to 200°C	100 %
over 200°C to 300°C	90 %
over 300°C to 400°C	75 %

If Grade 80 lifting chains are used at temperatures exceeding 200°C, then the working load limit has to be reduced. The manufacturer has to be consulted if lifting chains are used outside of the allowed temperature application range.

Table 4

Load Factors at Asymmetry

Number of strands	1		2		3		4			
	Inclination Angle β	Load Factor	Inclination Angle β	Load Factor	Inclination Angle β	Load Factor	Inclination Angle β	Load Factor		
	-	1	0° - 45°	1,4	46° - 60°	1	0° - 45°	2,1	46° - 60°	1,5

Table 5

Lifting Chains

The grade 80 lifting chains TWN 0805 are made from CrNiMo alloy steel and are used to assemble chain slings and lashing chains. The max. application temperature is 400°C. The manufacturing and testing requirements of these high-quality round steel chains are based on the DIN EN 818-2 and on the German Statutory Accident Insurance test principle GS-HM 37.

TWN 0805

Trade Size	Article-No.				Working Load Limit [t]	Nominal Size d_n [mm]	Pitch p_n [mm]	Inside Width w_3 [mm] min.	Outside Width w_2 [mm] max.	Weight app. [kgs/m]
	Self-Coloured	RAL 9005	Corrothiel	Electro-galvanized						
6-8	F01452	F01453	F01454	F01448	1,12	6	18	7,80	22,20	0,82
7-8	F01458	F01459	F01457	F014601	1,50	7	21	9,50	25,90	1,10
8-8	F01464	F01465	F01429	F01433	2,00	8	24	10,90	29,60	1,46
10-8	F01469	F01470	F01450	F01445	3,15	10	30	13,00	37,00	2,26
13-8	F01474	F01475	F01476	F014781	5,30	13	39	17,40	48,10	3,76
16-8	F01479	F01480	F01487	F014821	8,00	16	48	20,80	59,20	5,70
18-8	F01484	F01485	F04580	F01484G	10,00	18	54	23,40	66,60	7,10
20-8	F01494	F01495	F04606	F014944	12,50	20	60	26,00	74,00	9,00
22-8	F01499	F01500	F04629	F015111	15,00	22	66	28,60	81,40	10,90
26-8	F01514	F01515	F04695	*	21,20	26	78	33,80	96,20	15,20
28-8	F01519	F01520	F01521	-	25,00	28	84	36,40	104,00	17,60
32-8	F01524	F01525	F01526	F01527	31,50	32	96	41,60	118,00	23,00
36-8	F01529	F01530	F04814	-	40,00	36	108	46,80	133,00	29,00
40-8	F01534	F01535	F04838	-	50,00	40	120	52,00	148,00	36,00
45-8	F01539	F01540	F04889	-	63,00	45	135	58,50	167,00	45,50
50-8	F01545	F01546	F04900	-	80,00	50	150	65,00	185,00	56,00
56-8	F01555	F01556	F04908	-	100,00	56	168	72,80	207,00	72,50
63-8	-	F01566	-	-	125,00	63	190	81,90	233,00	89,00
71-8	-	F01598	-	-	160,00	71	210	92,30	263,00	113,00

* On request



TWN 0795

Intermediate Links Type B

The grade 80 intermediate links TWN 0795 are used to assemble chain slings. The dimensions comply with the DIN 5688-3 and enable the use of connecting links, e.g. a THI-LOK® TWN 1320. The manufacturing and testing requirements comply with the DIN EN 1677 parts 1 and 4.

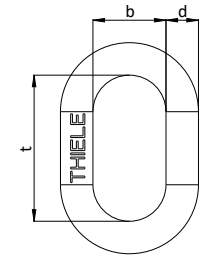

Trade Size	Article-No.	Working Load Limit $0^\circ < \beta \leq 45^\circ$ [t]	Dimensions [mm]			Weight app. [kgs]
			d	t	b	
B8	F122880	1,12	8	36	18	0,05
B10	F122890	2,00	10	46	23	0,09
B13	F122930	3,15	13	60	30	0,20
B16	F122970	5,30	16	70	35	0,36
B18	F123010	6,70	18	85	40	0,54
B20	F123030	8,00	20	90	45	0,73
B22	F123070	10,00	22	100	50	0,97
B26	F123090	12,50	26	120	60	1,60
B28	F123190	15,00	28	130	65	1,90
B32	F123110	21,20	32	140	70	2,90
B36	F123130	25,00	36	160	80	4,20
B40	F123150	31,50	40	180	90	5,80
B45	F123170	40,00	45	200	100	8,20
B50	F123210	50,00	50	220	110	11,00
B56	F123230	63,00	56	260	130	16,00
B63	F123270	80,00	63	280	140	22,00
B70	F123290	100,00	70	320	160	31,00
B80	F123300	125,00	80	360	180	46,50
B90	F123320	160,00	90	400	200	65,50



Suspension Components

Fixed-Size Master Links TAA1 for 1-leg Chain Slings

The grade 80 fixed size master links TWN 0810/1 are used to assemble 1-leg chain slings. The fixed installed ring shackles only allow the assembly of lifting chains of the appropriate nominal size. The dimensions of the fixed size master links type A comply with the DIN 5688-3. The manufacturing and testing requirements are based on the DIN EN 1677 parts 1 and 4.

Trade Size	Article-No.	Working Load Limit [t]	Dimensions [mm]				Weight app. [kgs]
			e	d	t	b	
6-8	F08101068	1,12	121	13	90	50	0,40
8-8	F08101088	2,00	147	16	110	60	1,00
10-8	F08101108	3,15	176	18	130	70	1,20
13-8	F08101138	5,30	219	22	160	90	2,30
16-8	F08101168	8,00	255	26	180	100	4,00
22-8	F08101228	15,00	350	36	250	140	10,00

TWN 0810/1

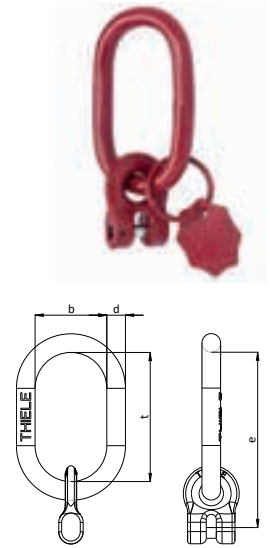

Fixed-Size Master Links TAA2 for 2-leg Chain Slings

The grade 80 fixed size master links TWN 0810/2 are used to assemble 2-leg chain slings. The fixed installed ring shackles only allow the assembly of lifting chains of the appropriate nominal size. The dimensions of the fixed size master links type A comply with the DIN 5688-3. The manufacturing and testing requirements are based on the DIN EN 1677 part 1 and part 4.

Trade Size	Article-No.	Working Load Limit $0^\circ < \beta \leq 45^\circ$ [t]	Dimensions [mm]				Weight app. [kgs]
			e	d	t	b	
6-8	F08102068	1,60	121	13	90	50	0,50
8-8	F08102088	2,80	167	18	130	70	1,20
10-8	F08102108	4,25	186	20	140	80	1,90
13-8	F08102138	7,50	239	26	180	100	4,00
16-8	F08102168	11,20	305	32	230	125	7,60
22-8	F08102228	21,20	420	45	320	175	19,60

TWN 0810/2

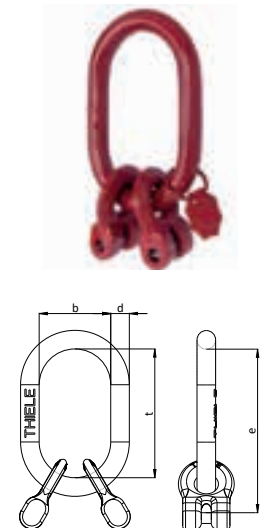

Fixed-Size Master Links TAA4 for 3- and 4-leg Chain Slings

The grade 80 fixed size master links TWN 0810/4 are used to assemble 3- and 4-leg chain slings. The fixed installed ring shackles only allow the assembly of lifting chains of the appropriate nominal size. The dimensions of the fixed size master links type A comply with the DIN 5688-3. The manufacturing and testing requirements are based on the DIN EN 1677 part 1 and part 4.

Trade Size	Article-No.	Working Load Limit $0^\circ < \beta \leq 45^\circ$ [t]	Dimensions [mm]				Weight app. [kgs]
			e	d	t	b	
6-8	F08104068	2,36	201	16	110	60	1,40
8-8	F08104088	4,25	267	22	160	90	3,10
10-8	F08104108	6,70	316	26	180	100	5,40
13-8	F08104138	11,20	409	32	230	125	11,10
16-8	F08104168	17,00	495	40	290	160	19,00
22-8	F08104228	31,50	620	50	340	190	42,80

TWN 0810/4

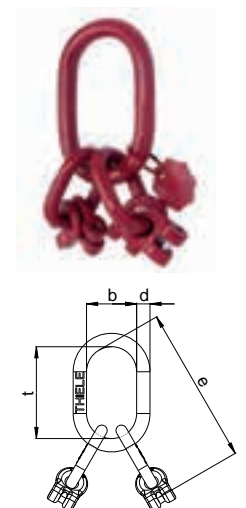

TWN 0811/1

Fixed-Size Master Links TAB1 for 1-leg Chain Slings

The grade 80 fixed size master links TWN 0811/1 are used to assemble 1-leg chain slings. The fixed installed ring shackles only allow the assembly of lifting chains of the appropriate nominal size. The dimensions of the fixed size master links type B comply with the DIN 5688-3. The manufacturing and testing requirements are based on the DIN EN 1677 parts 1 and 4.

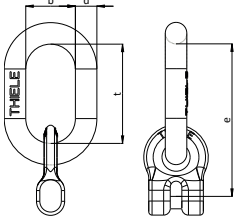

Trade Size	Article-No.	Working Load Limit [t]	Dimensions [mm]				Weight app. [kgs]
			e	d	t	b	
6-8	F08111068	1,12	91	13	60	30	0,31
8-8	F08111088	2,00	107	16	70	35	0,57
10-8	F08111108	3,15	136	20	90	45	1,14
13-8	F08111138	5,30	159	22	100	50	1,84
16-8	F08111168	8,00	195	26	120	60	3,20
18-8	F08111188	10,00	219	32	140	70	5,40
22-8	F08111228	15,00	260	36	160	80	8,00

TWN 0811/2

Fixed-Size Master Links TAB2 for 2-leg Chain Slings

The grade 80 fixed size master links TWN 0811/2 are used to assemble 2-leg chain slings. The fixed installed ring shackles only allow the assembly of lifting chains of the appropriate nominal size. The dimensions of the fixed size master links type B comply with the DIN 5688-3. The manufacturing and testing requirements are based on the DIN EN 1677 parts 1 and 4.

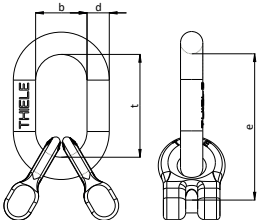

Trade Size	Article-No.	Working Load Limit $0^\circ < \beta \leq 45^\circ$ [t]	Dimensions [mm]				Weight app. [kgs]
			e	d	t	b	
6-8	F08112068	1,60	91	13	60	30	0,42
8-8	F08112088	2,80	107	16	70	35	0,78
10-8	F08112108	4,25	136	20	90	45	1,40
13-8	F08112138	7,50	179	26	120	60	2,71
16-8	F08112168	11,20	205	28	130	65	5,10
18-8	F08112188	14,00	219	32	140	70	7,90
22-8	F08112228	21,20	280	40	180	90	11,80

TWN 0811/4

Fixed-Size Master Links TAB4 for 3- and 4-leg Chain Slings

The grade 80 fixed size master links TWN 0811/4 are used to assemble 3- and 4-leg chain slings. The fixed installed ring shackles only allow the assembly of lifting chains of the appropriate nominal size. The dimensions of the fixed size master links type B comply with the DIN 5688-3. The manufacturing and testing requirements are based on the DIN EN 1677 parts 1 and 4.

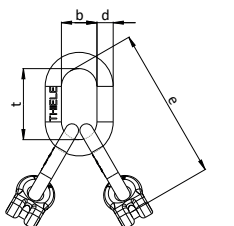

Trade Size	Article-No.	Working Load Limit $0^\circ < \beta \leq 45^\circ$ [t]	Dimensions [mm]				Weight app. [kgs]
			e	d	t	b	
6-8	F08114068	2,36	161	16	70	35	1,20
8-8	F08114088	4,25	197	20	90	45	2,29
10-8	F08114108	6,70	236	22	100	50	4,07
13-8	F08114138	11,20	299	26	120	60	8,28
16-8	F08114168	17,00	345	32	140	70	12,50
18-8	F08114188	21,20	379	36	160	80	20,00
22-8	F08114228	31,50	460	40	180	90	29,40

Suspension Components

Oversized Master Link Assemblies for 1-leg Chain Slings for Single Crane Hooks DIN 15401 (16 t, 25 t, 40 t)

The grade 80 oversized master link assemblies TWN 0815 are used to assemble 1-leg chain slings and are used with big crane hooks according to the DIN 15401. The manufacturing and testing requirements are based on the DIN EN 1677 parts 1 and 4. The dimensions comply with the DIN 5688-3. The intermediate links enable the use of connecting links, e.g. THI-LOK® TWN 1320.

TWN 0815

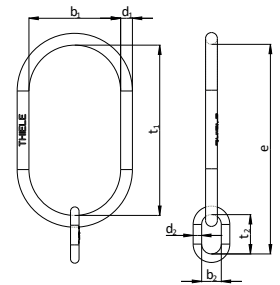

Trade Size	Article-No.	Working Load Limit [t]	Dimensions [mm]							Crane Hooks acc. DIN 15401	Weight app. [kgs]
			e	d ₁	t ₁	b ₁	d ₂	t ₂	b ₂		
6-8	F08150616	1,12	320	18	260	140	13	60	30	16	1,67
8-8	F08150816	2,00	330	22	260	140	16	70	35	16	2,60
10-8	F08151016	3,15	330	22	260	140	16	70	35	16	2,60
13-8	F08151316	5,30	260	26	260	140				16	3,17
16-8	F08151616	8,00	260	30	260	140				16	4,30
18-8	F08151816	10,00	370	36	250	140	26	120	60	16	7,80
6-8	F08150625	1,12	400	20	340	180	13	60	30	25	2,54
8-8	F08150825	2,00	400	20	340	180	13	60	30	25	2,54
10-8	F08151025	3,15	410	24	340	180	16	70	35	25	3,78
13-8	F08151325	5,30	410	28	340	180	16	70	35	25	5,07
16-8	F08151625	8,00	430	32	340	180	20	90	45	25	6,95
18-8	F08151825	10,00	440	40	340	180	22	100	50	25	10,90
20-8	F08152025	12,50	340	40	340	180				25	10,00
22-8	F08152225	15,00	340	40	340	180				25	10,00
6-8	F08150640	1,12	490	22	430	220	13	60	30	40	3,73
8-8	F08150840	2,00	490	22	430	220	13	60	30	40	3,73
10-8	F08151040	3,15	500	26	430	220	16	70	35	40	5,33
13-8	F08151340	5,30	500	30	430	220	16	70	35	40	7,05
16-8	F08151640	8,00	520	34	430	220	20	90	45	40	9,41
18-8	F08151840	10,00	530	42	430	220	22	100	50	40	14,50
20-8	F08152040	12,50	430	42	430	220				40	13,50
22-8	F08152240	15,00	430	42	430	220				40	13,52

Oversized Master Link Assemblies for 2-leg Chain Slings for Single Crane Hooks DIN 15401 (16 t, 25 t, 40 t)

The grade 80 oversized master link assemblies TWN 0816 are used to assemble 2-leg chain slings and are used with big crane hooks according to the DIN 15401. The manufacturing and testing requirements are based on the DIN EN 1677 parts 1 and 4. The dimensions comply with the DIN 5688-3. The intermediate links enable the use of connecting links, e.g. THI-LOK® TWN 1320.

TWN 0816

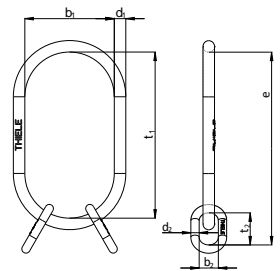

Trade Size	Article-No.	Working Load Limit 0° $\beta \leq 45^\circ$ [t]	Dimensions [mm]							Crane Hooks acc. DIN 15401	Weight app. [kgs]
			e	d ₁	t ₁	b ₁	d ₂	t ₂	b ₂		
6-8	F08160616	1,60	320	18	260	140	13	60	30	16	1,88
8-8	F08160816	2,80	330	22	260	140	16	70	35	16	2,96
10-8	F08161016	4,25	330	26	260	140	16	70	35	16	3,90
13-8	F08161316	7,50	350	30	260	140	20	90	45	16	5,75
16-8	F08161616	11,20	370	36	250	140	26	120	60	16	9,43
6-8	F08160625	1,60	400	22	340	180	13	60	30	25	2,70
8-8	F08160825	2,80	410	24	340	180	16	70	35	25	4,14
10-8	F08161025	4,25	410	28	340	180	16	70	35	25	5,43
13-8	F08161325	7,50	430	32	340	180	20	90	45	25	7,68
16-8	F08161625	11,20	440	40	340	180	22	100	50	25	11,90
18-8	F08161825	14,00	440	40	340	180	22	100	50	25	11,90
20-8	F08162025	17,00	480	45	340	180	32	140	70	25	18,60
6-8	F08160640	1,60	490	26	430	220	16	70	35	40	5,70
8-8	F08160840	2,80	500	26	430	220	13	60	30	40	5,70
10-8	F08161040	4,25	500	30	430	220	16	70	35	40	7,42
13-8	F08161340	7,50	520	34	430	220	20	90	45	40	9,88
16-8	F08161640	11,20	530	42	430	220	22	100	50	40	15,50
18-8	F08161840	14,00	530	42	430	220	22	100	50	40	15,50
22-8	F08162240	21,20	570	48	430	220	32	140	70	40	23,70

TWN 0817

Oversized Master Link Assemblies for 3- and 4-leg Chain Slings for Single Crane Hooks DIN 15401 (16 t, 25 t, 40 t)

The grade 80 oversized master link assemblies TWN 0817 are used to assemble 3- and 4-leg chain slings and are used with big crane hooks according to the DIN 15401. The manufacturing and testing requirements are based on the DIN EN 1677 parts 1 and 4. The dimensions comply with the DIN 5688-3. The intermediate links enable the use of connecting links, e.g. THI-LOK®s TWN 1320.

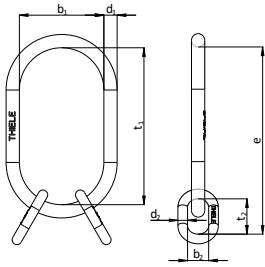

Trade Size	Article-No.	Working Load Limit $0^\circ \leq \beta \leq 45^\circ$ [t]	Dimensions [mm]							Crane Hooks acc. DIN 15401	Weight app. [kgs]
			e	d ₁	t ₁	b ₁	d ₂	t ₂	b ₂		
6-8	F08170616	2,36	320	22	260	140	13	60	30	16	2,96
8-8	F08170816	4,25	330	26	260	140	16	70	35	16	3,90
10-8	F08171016	6,70	350	30	260	140	20	90	45	16	5,75
13-8	F08171316	11,20	370	36	250	140	26	120	60	16	9,43
16-8	F08171616	17,00	370	36	250	140	26	120	60	16	9,43
6-8	F08170625	2,36	400	24	340	180	13	60	30	25	4,14
8-8	F08170825	4,25	410	28	340	180	16	70	35	25	5,43
10-8	F08171025	6,70	430	32	340	180	20	90	45	25	7,68
13-8	F08171325	11,20	440	40	340	180	22	100	50	25	11,90
16-8	F08171625	17,00	460	40	340	180	26	120	60	25	13,20
20-8	F08172025	26,50	590	55	430	220	36	160	80	25	32,30
6-8	F08170640	2,36	490	26	430	220	13	60	30	40	5,70
8-8	F08170840	4,25	500	30	430	220	16	70	35	40	7,42
10-8	F08171040	6,70	520	34	430	220	20	90	45	40	10,10
13-8	F08171340	11,20	530	42	430	220	22	100	50	40	15,50
16-8	F08171640	17,00	550	42	430	220	26	120	60	40	16,80
18-8	F08171840	21,20	570	48	430	220	32	140	70	40	23,70
22-8	F08172240	31,50	590	55	430	220	36	160	80	40	32,30

TWN 0820

Clevis Suspension Links

The grade 80 clevis suspension links TWN 0820 are predominantly used to assemble 1-leg basket slings for bundling of loads. The manufacturing and testing requirements are based on the DIN EN 1677-1.

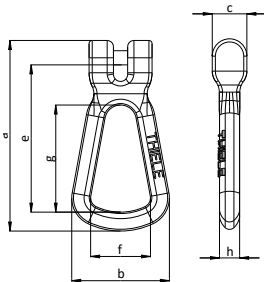

Trade Size	Article-No.	Working Load Limit [t]	Dimensions [mm]							Weight app. [kgs]
			e	f	g	a	c	h	b	
8-8	F31000	2,00	93,5	38	68	121	22	13	62	0,36
10-8	F31010	3,15	126	49	95	165,5	28	19	88	0,86
13-8	F31020	5,30	158,5	60	120	207	37	22	104	1,60
16-8	F31030	8,00	187	80	140	246	43	28	136	3,00

Suspension Components

Master Links Type A for 1- and 2-leg Chain Slings

The grade 80 master links TWN 1313 are used to assemble 1- and 2-leg chain slings. The dimensions comply with the DIN 5688-3 and enable the use of connecting links, e.g. THI-LOK®'s TWN 1320. The possibility of using the links for single- and double-leg chain slings offers a high flexibility and economical warehousing. The master links can be used e.g. to assemble wire rope slings according to the DIN EN 13414-1. The manufacturing and testing requirements are based on the DIN EN 1677 parts 1 and 4.

Article-No.	Working Load Limit $0^\circ < \beta \leq 45^\circ$ [t]	Dimensions [mm]			Weight app. [kgs]	Trade Size for use in Chain Slings		Crane Hooks acc. DIN 15401
		d	t	b		1-leg	2-leg	
F1313013	2,00	13	90	50	0,29	6/7-8	6-8	1,6
F1313016	3,15	16	110	60	0,53	8-8	7-8	2,5
F1313018	4,00	18	130	70	0,79	10-8	8-8	4
F1313020	4,75	20	140	80	1,10		10-8	5
F1313022	5,60	22	160	90	1,50	13-8		6
F1313026	8,00	26	180	100	2,30	16-8	13-8	8
F1313032	12,50	32	230	125	4,40	18/20-8	16-8	12
F1313036	16,00	36	250	140	6,20	22-8	18-8	16
F1313040	19,00	40	290	160	8,80		20-8	20
F1313045	25,00	45	320	175	12,00	26/28-8	22-8	25
F1313050	31,50	50	340	190	16,00	32-8	26-8	25
F1313056	40,00	56	380	210	23,00	36-8	28-8	32
F1313063	50,00	63	430	240	33,00	40-8	32-8	40
F1313070	63,00	70	470	260	44,00	45-8	36-8	50
F1313080	80,00	80	520	290	64,00	50-8	40-8	63
F1313085	100,00	85	520	290	73,00	56-8	45-8	63
F1313095	125,00	95	580	320	100,00	63-8	50-8	80
F1313110	160,00	110	680	380	160,00	71-8	56-8	100

TWN 1313

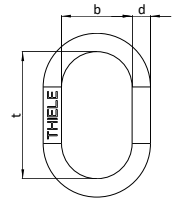

Master Link Assemblies for 3- and 4-leg Chain Slings

The grade 80 master link assemblies TWN 1314 are used to assemble 3- and 4-leg chain slings. The manufacturing and testing requirements are based on the DIN EN 1677, parts 1 and 4. The dimensions comply with the DIN 5688-3 and enable the use of connecting links, e.g. THI-LOK®'s TWN 1320. Furthermore, the master link assemblies can be used e.g. to assemble wire rope slings according to the DIN EN 13414-1.

Article-No.	Working Load Limit $0^\circ < \beta \leq 45^\circ$ [t]	Dimensions [mm]							Weight app. [kgs]	Trade Size for use in Chain Slings
		e	d ₁	t ₁	b ₁	d ₂	t ₂	b ₂		
F1314016	3,15	170	16	110	60	13	60	30	1,40	6-8
F1314020	4,75	210	20	140	80	16	70	35	1,80	8-8
F1314026	8,00	270	26	180	100	20	90	45	3,80	10-8
F1314032	12,50	350	32	230	125	26	120	60	7,70	13-8
F1314040	19,00	420	40	290	160	28	130	65	13,00	16-8
F1314045	25,00	460	45	320	175	32	140	70	18,00	18-8
F1314050	31,50	500	50	340	190	36	160	80	25,00	20-8
F1314050A	31,50	520	50	340	190	40	180	90	28,00	22-8
F1314063	50,00	630	63	430	240	45	200	100	49,00	26-8
F1314063A	50,00	630	63	430	240	45	200	100	49,00	28-8
F1314080	71,00	740	80	520	290	50	220	110	86,00	32-8
F1314085	85,00	780	85	520	290	56	260	130	106,00	36-8
F1314095	112,00	860	95	580	320	63	280	140	146,00	40-8
F1314110	132,00	1000	110	680	380	70	320	160	223,00	45-8
F1314110A	160,00	1040	110	680	380	80	360	180	252,00	50-8

TWN 1314

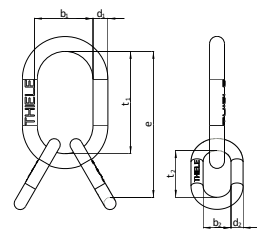

TWN 1315

Master Link Assemblies for 3- and 4-leg Rope Slings

The grade 80 master link assemblies TWN 1315 are used to assemble 3- and 4-leg wire rope slings. The extra large intermediate links enable easy assembly of wire rope slings. The manufacturing and testing requirements are based on the DIN EN 1677 parts 1 and 4. The dimensions comply with the DIN 5688-3.

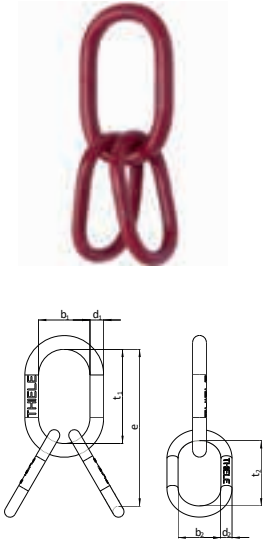

Article-No.	Working Load Limit $0^\circ < \beta \leq 45^\circ$ SF = 1:4 [t]	Dimensions [mm]							Weight app. [kgs]	Classification of the Wire Rope Diameter*	
		d_1	t_1	b_1	e	d_2	t_2	b_2		Fiber [mm]	Steel [mm]
F1315016	2,80	16	110	60	200	13	90	50	1,11	11	10
F1315018	4,00	18	130	70	240	16	110	60	1,85	13	12
F1315022	5,30	22	160	90	290	18	130	70	3,08	14	14
F1315026	7,50	26	180	100	340	22	160	90	5,40	18	16
F1315032	11,10	32	230	125	410	26	180	100	9,10	22	20
F1315036	16,00	36	250	140	480	32	230	125	15,00	26	24
F1315045	21,00	45	320	175	570	36	250	140	24,40	28	28
F1315050	31,60	50	340	190	660	45	320	175	40,40	36	36
F1315056	40,20	56	380	210	720	50	340	190	55,40	40	40
F1315063	50,10	63	430	240	810	56	380	210	78,40	44	44
F1315085	101,80	85	520	290	1.040	80	520	290	201,00	60	60

*Acc. to the DIN EN 13414-1 for 3- and 4-leg slings.

Connectors

TWN 1320

THI-LOK® Connecting Links

The grade 80 THI-LOK® connecting links TWN 1320 are used to connect lifting chains with lifting components to assemble chain slings. The manufacturing and testing requirements are based on the DIN EN 1677-1.

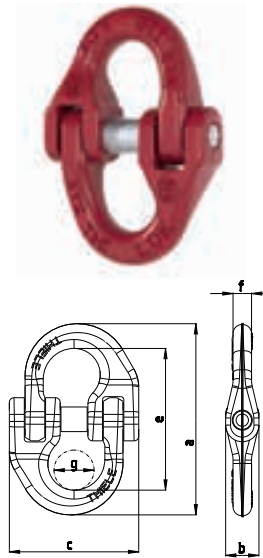

Trade Size	Article-No.	Working Load Limit $0^\circ < \beta \leq 45^\circ$ [t]	Dimensions [mm]						Weight app. [kgs]
			e	g	a	c	b	f	
6-8	F308061	1,12	39	13	53	38	11	7	0,08
7-8	NEW F308151	1,50	47	16	65	48	13	8	0,12
8-8	F308161	2,00	54	18	74	53	14	9	0,17
10-8	F308261	3,15	64	22	88	62	18	12	0,29
13-8	F308361	5,30	86	26	118	77	23	15	0,62
16-8	F308461	8,00	102	36	141	100	29	19	1,16
18-8	F308561	10,00	115	36	157	111	32	21	1,63
20-8	F308661	12,50	128	45	175	130	36	23	2,30
22-8	F308761	15,00	141	45	193	139	39	25	2,99
26-8	F308861	21,20	166	56	228	165	46	29	4,90
32-8	F308961	31,50	204	70	282	209	57	38	9,65
36-8	NEW F309061	40,00	230	80	321	244	66	44	15,00
40-8	NEW F309161	50,00	230	80	321	244	66	44	15,00

Hooks

Eye Self-Locking Hooks

The grade 80 self-locking hooks with eye TWN 0798 are used to assemble chain slings and are often used in the construction industry. The associated lifting chains are assembled by using connecting links, e.g. THI-LOK®s TWN 1320. The hooks lock automatically when under load and may only be reopened manually if not under load anymore. The self-locking hooks comply with the DIN EN 1677-3.

Trade Size	Article-No.	Working Load Limit [t]	Dimensions [mm]					Weight app. [kgs]
			e	d	g	h	c	
6-8	Z07274	1,12	106	22,5	28	22	15	0,48
7/8-8	Z07275	2,00	133	24	35	25	20	0,82
10-8	Z07276	3,15	167	32	45	35	27	1,65
13-8	Z07277	5,30	208	39	54	41	33	3,12
16-8	Z07278	8,00	250	49	67	54	39	5,88
18/20-8	F092255	12,50	257	60	74	57	43	7,33
22-8	F092275	15,00	290	71	88	62	52	9,91

TWN 0798

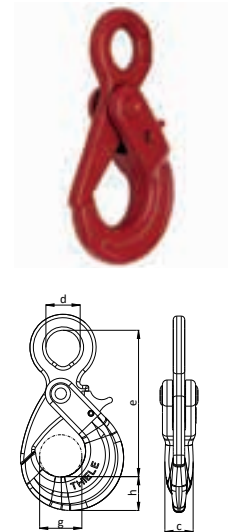

Clevis Self-Locking Hooks

The grade 80 clevis self-locking hooks TWN 0799 are used to assemble chain slings and are often used in the construction industry. The clevis design enables the direct attachment to the lifting chain. The hooks lock automatically when under load and may only be reopened manually if not under load anymore. The self-locking hooks comply with the DIN EN 1677-3.

Trade Size	Article-No.	Working Load Limit [t]	Dimensions [mm]				Weight app. [kgs]
			e	g	h	c	
6-8	Z07279	1,12	98	28	22	15	0,57
8-8	Z07280	2,00	122	33	25	20	0,93
10-8	Z07281	3,15	150	45	35	27	1,75
13-8	Z07282	5,30	186	54	41	33	3,25
16-8	Z07296	8,00	215	67	54	39	6,20
18/20-8	F0922055	12,50	215	74	57	43	7,28

TWN 0799

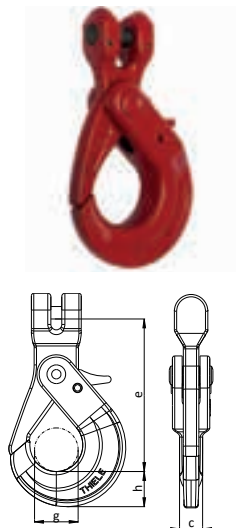

Swivel Hooks

The grade 80 swivel hooks TWN 0854 are used to assemble chain slings. The swivels enable the chain strands to be aligned without twisting. The lifting chains are assembled by using connecting links, e.g. THI-LOK®s TWN 1320. The manufacturing and testing requirements comply with the DIN EN 1677-2.

Trade Size	Article-No.	Working Load Limit $0^\circ < \beta \leq 45^\circ$ [t]	Dimensions [mm]										Weight app. [kgs]
			d	f	b	e	g	a	c	h	l	m	
0,75 t	F32103	0,75	10	25	30	113,5	19	50	13	14	62,5	42,5	0,37
6-8	F32100	1,12	10	25	30	113	21	50	14	19	73	52	0,38
8-8	F32110	2,00	16	42	44	155	25	76	19	24,5	88	68	1,00
10-8	F32120	3,15	16	42	44	162	28	76	20,5	28,5	104	72	1,20
13-8	F32130	5,30	19	43	51	190	34	89	28	33	120	87	2,08
16-8	F32140	8,00	25	60	64	247	42	114	35	43	156	110	4,45

TWN 0854

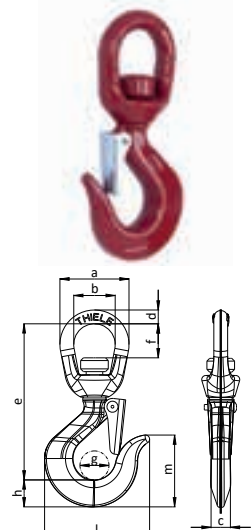

TWN 0855

Eye Sling Hooks

The grade 80 eye sling hooks TWN 0855 are used to assemble chain slings. The lifting chains are assembled by using connecting links, e.g. THI-LOK®s TWN 1320. The manufacturing and testing requirements comply with the DIN EN 1677-2.

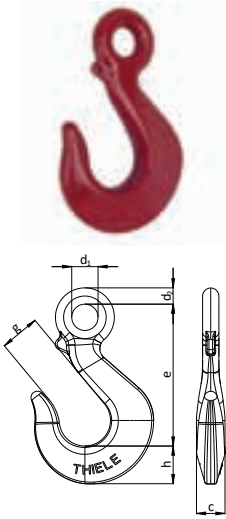

Trade Size	Article-No.	Working Load Limit [t]	Dimensions [mm]						Weight app. [kgs]
			e	d ₁	g	h	c	d ₂	
36-8	Z04079	40,00	388	72	109	103	78	44,5	31,50
40-8	Z04083	50,00	442	84	124	116	89	50,5	46,00
45-8	Z04080	63,00	494	90	138	130	99	56	63,00
50-8	Z04081	80,00	610	102	155	145	110	63	80,00

TWN 0855/1

Eye Sling Hook with Safety Latch

The grade 80 eye sling hooks TWN 0855/1 are used to assemble chain slings. The lifting chains are assembled by using connecting links, e.g. THI-LOK®s TWN 1320. The safety latch prevents unintentional detachment from the load. The sling hooks comply with the DIN EN 1677-2.

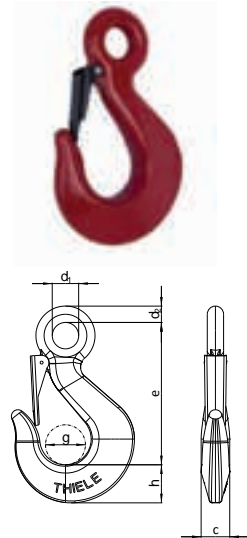

Trade Size	Article-No.	Working Load Limit [t]	Dimensions [mm]						Weight app. [kgs]
			e	d ₁	g	h	c	d ₂	
36-8	Z06159	40,00	388	72	90	103	78	44,5	32,30
40-8	Z06160	50,00	442	84	103	116	89	50,5	47,00
45-8	Z06161	63,00	494	90	114	130	99	56	64,40
50-8	Z06162	80,00	610	102	131	145	110	63	81,90

TWN 0856

Eye Foundry Hooks

The grade 80 eye foundry hooks TWN 0856 are used to assemble chain slings, primarily for foundries. The associated lifting chains are assembled by using connecting links, e.g. THI-LOK®s TWN 1320. The manufacturing and testing requirements comply with the DIN EN 1677-1.

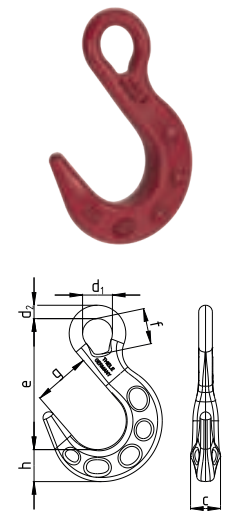

Trade Size	Article-No.	Working Load Limit [t]	Dimensions [mm]							Weight app. [kgs]
			e	d ₁	g	h	c	d ₂	f	
6-8	NEW F32354	1,12	108	21 ¹⁾	50	24	20	12	-	0,44
7/8-8	NEW F32364	2,00	135	28 ¹⁾	66	33	26	14	-	0,97
10-8	NEW F32374	3,15	161	32 ¹⁾	76	35	32	18	-	1,56
13-8	NEW F32384	5,30	196	42 ¹⁾	89	42	38	21	-	2,96
16-8	NEW F32394	8,00	229	54 ¹⁾	102	48	45	23	-	4,71
18/20-8	NEW F32404	12,50	259	59	114	63	59	27,0	70	7,95
22-8	NEW F32414	15,00	288	65	127	70	65	30	78	10,88
26-8	NEW F32424	21,20	329	76	136	81	75	35	89	16,49
32-8	NEW F32444	31,50	358	85	152	97	83	42	100	26,20

¹⁾ With circular eyelet

Eye Foundry Hooks with Handle NEW

The grade 80 eye foundry hooks with handle TWN 0856/1 are used to assemble chain slings, primarily for foundries. The associated lifting chains are assembled by using connecting links, e.g. THI-LOK®s TWN 1320. The handle ensures a safe and easy handling. The manufacturing and testing requirements comply with the DIN EN 1677-1.

Trade Size	Article-No.	Working Load Limit [t]	Dimensions [mm]										Weight app. [kgs]
			e	d ₁	g	h	c	d ₂	a	b	d ₃	f	
16-8	F32396	8,00	229	54 ¹⁾	102	48	45	23	60	110	16	-	5,20
18/20-8	F32406	12,50	259	59	114	63	59	27,0	60	110	16	70	8,40

¹⁾ With circular eyelet

TWN 0856/1

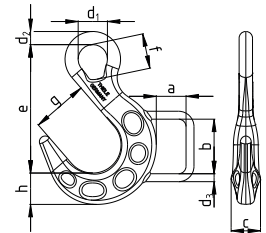

SOLIDO® Eye Sling Hooks with forged Safety Latch

The grade 80 eye sling hooks TWN 0858/1 are used to assemble standard chain slings. The lifting chains are assembled by using connecting links, e.g. THI-LOK®s TWN 1320. The forged safety latch prevents an unintentional detachment from the load. The sling hooks comply with the DIN EN 1677-2.

Trade Size	Article-No.	Working Load Limit [t]	Dimensions [mm]							Weight app. [kgs]
			e	d ₁	d ₂	g	h	c	f	
6-8	F329010	1,12	92	21 ¹⁾	11	24	20	17	-	0,36
7/8-8	F329110	2,00	118	28 ¹⁾	14	30	25	20	-	0,76
10-8	F329210	3,15	146	36 ¹⁾	18	37	32	29	-	1,50
13-8	F329310	5,30	168	42 ¹⁾	21	42	41	35	-	2,55
16-8	F329410	8,00	210	54 ¹⁾	25	51	50	41	-	4,65
18/20-8	F32951	12,50	270	62 ¹⁾	30	65	58	55	-	8,70
22-8	F329710	15,00	271	65 ¹⁾	30	70	62	55	-	10,20
26-8	F329810	21,20	302	70	33	75	71	60	81	15,00
32-8	F329910	31,50	350	80	38	90	84	70	99	24,30

¹⁾ With circular eyelet

TWN 0858/1

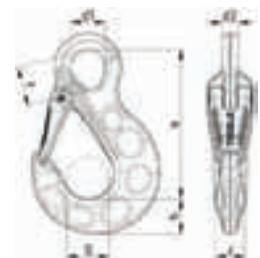

Clevis Foundry Hooks

The grade 80 clevis foundry hooks TWN 0859 are used to assemble chain slings, primarily for foundries. The manufacturing and testing requirements comply with the DIN EN 1677-1.

Trade Size	Article-No.	Working Load Limit [t]	Dimensions [mm]				Weight app. [kgs]
			e	g	h	c	
8-8	F33310	2,00	110	66	33	27	1,12
10-8	F33320	3,15	133	76	35	32	1,61
13-8	F33330	5,30	159	89	41	38	3,40
16-8	F33340	8,00	189	102	48	45	5,50
20-8	F33355	12,50	217	114	54	51	9,00
22-8	F33360	15,00	244	124	60	56	12,00

TWN 0859

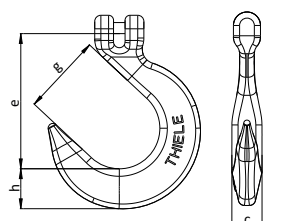

TWN 0860

S-Hooks

The grade 80 S-hooks TWN 0860 can be used universally for lifting of loads, also in combination with chain slings. The manufacturing and testing requirements are based on the DIN EN 1677-1.

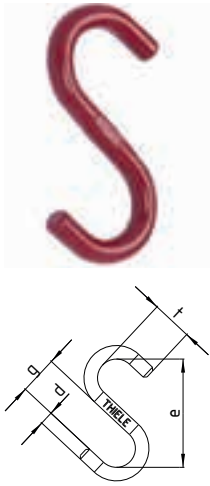

Trade Size	Article-No.	Working Load Limit [t]	Dimensions [mm]				Weight app. [kgs]
			e	g	t	d	
	F18130	0,15	80	28	30	10	0,12
	F18160	0,25	100	36	38	12	0,21
	F18180	0,40	130	46	48	16	0,48
	F18200	0,80	160	56	58	20	0,91
6-8	F18220	1,12	180	64	64	22	1,20
7-8	F18230	1,50	200	70	70	26	1,90
8-8	F18250	2,00	230	80	80	32	3,40
10-8	F18260	3,15	260	90	90	36	4,80
	F18280	4,00	300	104	104	40	6,80
	F18290	4,50	350	122	121	45	10,00
13-8	F18300	5,30	400	140	138	51	14,60
	F18310	6,00	450	158	154	57	20,50
16-8	F18320	8,00	500	160	160	63	27,40
18-8	F18330	10,00	550	166	168	72	39,00

TWN 0868

Pipe Transport Hooks

The grade 80 pipe transport hooks TWN 0868 are used as forged end fittings in 2-leg chain slings to lift pipes. The lifting chains are assembled by using connecting links, e.g. THI-LOK®s TWN 1320. The manufacturing and testing requirements are based on the DIN EN 1677-1.

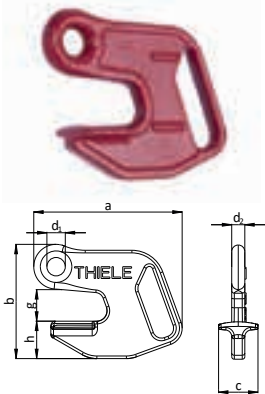

Trade Size	Article-No.	Working Load Limit [t]	Dimensions [mm]							Weight app. [kgs]
			b	a	d ₁	d ₂	g	h	c	
13-8	F32608	5,30	174	226	28	20	49	57	60	3,10
22-8	F32641	15,00	274	345	44	30	80	90	95	14,62

TWN 0872

Plate Hooks for Basket Chains

The grade 80 plate hooks with intermediate link TWN 0872 are used as end fittings of chain slings for the horizontal transportation of thick-walled sheet metals in steel constructions. The intermediate links enable the connection of additional slings. The hooks are used in 2-leg basket chain slings, the max. inclination angle is $\beta = 30^\circ$. The manufacturing and testing requirements are based on the DIN EN 1677-1.

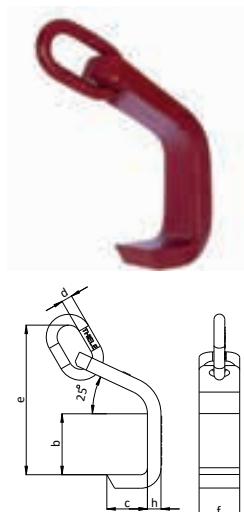

Trade Size	Article-No.	Working Load Limit $15^\circ < \beta \leq 30^\circ$ [t]	Dimensions [mm]						Weight app. [kgs]
			e	b	c	d	f	h	
6-8	F35500	1,60	221	90	60	16	60	20	2,50
8-8	F35501	2,80	244	90	90	16	70	25	4,00
10-8	F35502	4,25	332	140	95	18	80	30	10,08
13-8	F35503	7,50	360	145	105	22	90	35	11,00
16-8	F35504	11,20	404	155	120	26	110	45	16,80
20-8	F35505	17,00	445	175	130	32	120	55	30,00
22-8	F35506	21,20	510	205	135	36	140	60	40,30
26-8	F35507	30,00	560	230	145	45	160	70	61,50
32-8	F35508	45,00	621	255	160	50	180	85	85,50

Plate Hooks for Spreader Chains

The grade 80 plate hooks with eyelet TWN 0873 are used as end fittings in chain slings for the horizontal transportation of thick-walled sheet metals in steel constructions. The eyelet allows the chain to be passed through. The max. inclination angle is $\beta = 30^\circ$. The manufacturing and testing requirements are based on the DIN EN 1677-1.

Trade Size	Article-No.	Working Load Limit $15^\circ < \beta \leq 30^\circ$ [t]	Dimensions [mm]					Weight app. [kgs]
			b	c	d	f	h	
6-8	F35600	1,60	90	60	38	60	20	2,40
8-8	F35601	2,80	90	90	42	70	25	3,50
10-8	F35602	4,25	140	95	50	80	30	8,00
13-8	F35603	7,50	145	100	65	90	35	12,52
16-8	F35604	11,20	155	120	78	110	45	22,00
20-8	F35605	17,00	175	130	92	130	55	25,00
22-8	F35606	21,20	205	135	100	140	60	34,00
26-8	F35607	30,00	230	145	118	160	70	50,00
32-8	F35608	45,00	255	160	142	190	85	69,00

TWN 0873

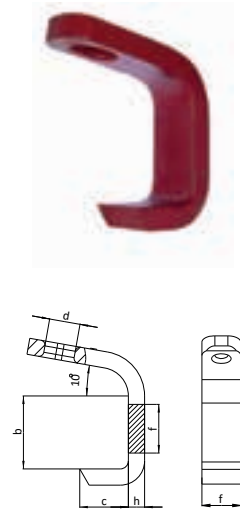

Engine-Transport Clevis Hooks

The grade 80 engine-transport hooks TWN 0889 are used in chain slings as end fittings, predominantly for the transportation of engine blocks. The tip shape enables the attachment to small eyelets. The manufacturing and testing requirements are based on the DIN EN 1677-1.

Trade Size	Article-No.	Working Load Limit [t]	Dimensions [mm]				Weight app. [kgs]
			e	g	h	c	
6-8*	F33439	0,50	137	19	13	12	0,55

*Compatible with trade size 6-8, but WLL limited to max 0,5 t.

TWN 0889

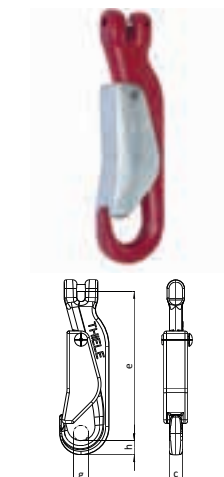

Clevis Sling Hooks with Forged Safety Latch

The grade 80 clevis sling hooks TWN 1340/1 are used to assemble universal chain slings and lashing chains. The clevis design enables the direct attachment to the lifting chain. The forged safety latch prevents an unintentional detachment from the load. The sling hooks comply with the DIN EN 1677-2.

Trade Size	Article-No.	Working Load Limit [t]	Dimensions [mm]				Weight app. [kgs]
			e	g	h	c	
6-8	F336010	1,12	76	24	20	17	0,36
8-8	F336110	2,00	95	30	25	22	0,76
10-8	F336210	3,15	114	37	32	28	1,41
13-8	F336310	5,30	134	42	41	35	2,48
16-8	F336410	8,00	162,5	51	50	41	6,00
20-8	F336510	12,50	201	54	61	62	8,15
20-8 ¹⁾	F33656	12,50	220	65	58	55	9,68
22-8	F336610	15,00	224	70	62	55	11,46
22-8 ¹⁾	F33661	15,00	244	75	64	61	10,62

¹⁾TWN 0835/1

TWN 1340/1

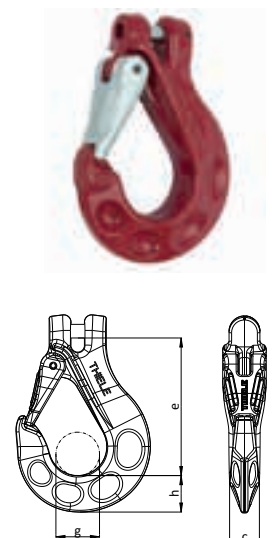

TWN 1399

Clevis Skip Suspension Hooks NEW

The grade 80 skip suspension hooks TWN 1399 connect chain slings with the pivot of containers, e.g. containers according to DIN 30720. The shape of the hooks is designed to fit container lifting pivots. The clevis design enables the direct attachment to the lifting chain. The hooks lock automatically when under load and may only be reopened manually if not under load anymore. The skip suspension hooks comply with the DIN EN 1677-3.

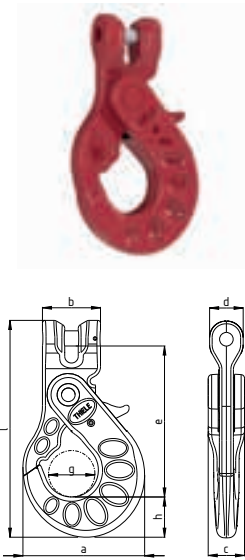

Trade Size	Article-No.	Working Load Limit [t]	Dimensions [mm]								Weight app. [kgs]
			e	c	g	h	d	b	a	l	
13-8	F335000	5,30	167	40	51	42	37	64	135	239	3,34
16-8	F335300	8,00	165	40	51	42	37	64	135	239	3,34

TWN 0869

Clevis Skip Suspension Links for One-Hand Operation and Forged Safety Latch

The grade 80 skip suspension links TWN 0869 connect chain slings with the pivot of containers, e.g. containers according to DIN 30720. The shape of the eyelet is designed to fit container suspension pivots. The clevis design enables the direct attachment to the lifting chain. The forged safety latch allows a safe one-hand operation. The manufacturing and testing requirements are based on DIN EN 1677 parts 1 and 4.

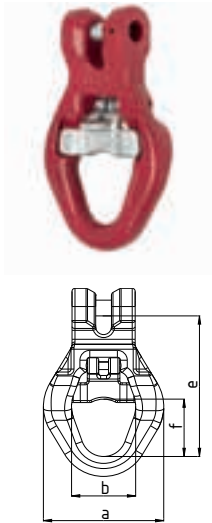

Trade Size	Article-No.	Working Load Limit [t]	Dimensions [mm]				Weight app. [kgs]
			e	f	b	a	
13-8	F313800	5,30	142	57,5	65	122	1,92
16-8	F313850	8,00	141	57,5	65	122	1,92

TWN 0869/1

Container Pivots

The container pivots TWN 0869/1 are welded to containers and serve as lifting points for attaching skip suspension hooks and links.

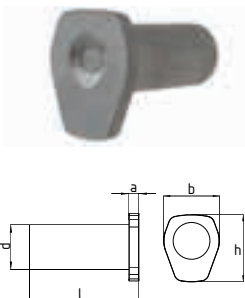

Article-No.	Dimensions [mm]					Weight app. [kgs]
	a	d	b	l	h	
F31410	10	45	68	110	82	1,60

Shortening Components

Clevis Shortening Hooks

The grade 80 clevis shortening hooks TWN 0827 are used to adjust the strand lengths of chain slings. The clevis design enables the direct attachment to the lifting chain. The manufacturing and testing requirements comply with the DIN EN 1677-1.

Trade Size	Article-No.	Working Load Limit [t]	Dimensions [mm]				Weight app. [kgs]
			e	g	l	b	
8-8	F33200	2,00	61	9,5	102	61	0,53
10-8	F33210	3,15	73	12	125	75	0,97
13-8	F33220	5,30	94	15	160	95	2,00
16-8	F33230	8,00	112	18	188	120	3,40
20-8	F33245	12,50	148	22,5	242	141	7,30

TWN 0827

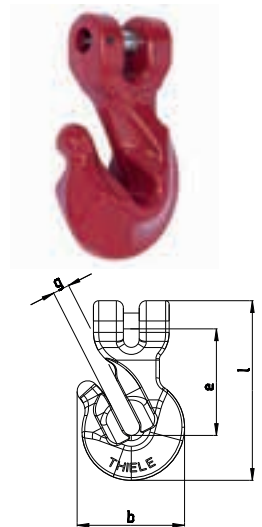

Clevis Shortening Hooks with Safety Pin

The grade 80 clevis shortening hooks with safety pin TWN 0827/1 are used to adjust the strand length of chain slings and lashing chains. The clevis design enables the direct attachment to the lifting chain. The safety pin prevents the chain from accidental release. The manufacturing and testing requirements correspond to the DIN EN 1677-1 and DIN 5692.

Trade Size	Article-No.	Working Load Limit [t]	Dimensions [mm]				Weight app. [kgs]
			e	g	l	b	
8-8	F33201	2,00	61	9,5	102	61	0,54
10-8	F33211	3,15	73	12	125	75	0,99
13-8	F33221	5,30	94	15	160	95	2,06
16-8	F33231	8,00	112	18	188	120	3,45
20-8	F33246	12,50	148	22,5	242	141	7,35

TWN 0827/1

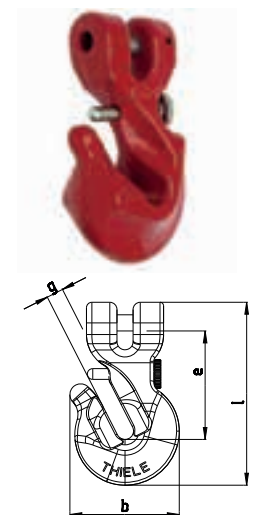

Clevis Shortening Claws

The grade 80 clevis shortening claws TWN 0851 are used to adjust the strand lengths of chain slings. The clevis design enables the direct attachment to the lifting chain. The manufacturing and testing requirements comply with the DIN EN 1677-1.

Trade Size	Article-No.	Working Load Limit [t]	Dimensions [mm]				Weight app. [kgs]
			e	a	b	l	
18-8	F34960	10,00	162	69	98	241	5,40
20-8	F34970	12,50	158	69	98	241	5,40
22-8	F34980	15,00	198	84	118	295	8,82
26-8	F34985	21,20	195	94	130	309	12,00
32-8	F34990	31,50	240	115	160	381	23,90

TWN 0851



TWN 0851/1

Clevis Shortening Claws with Safety Pin

NEW

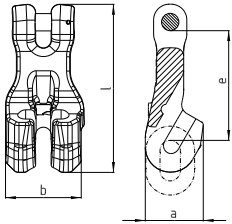

The grade 80 clevis shortening claws with safety pin TWN 0851/1 are used to adjust the strand lengths of chain slings, lifting and lashing chains. The clevis design enables the direct attachment to the lifting chain. The safety pin prevents unintentional detachment of the chain. The manufacturing and testing requirements comply with the DIN EN 1677-1 and DIN 5692. The shortening claws have been tested in interaction with the lifting chain. The chain pockets ensure a particularly tight fit for the inserted chain link. The safety bolt enables the use in lashing chains according to the DIN EN 12195-3.

Trade Size	Article-No.	Working Load Limit [t]	Dimensions [mm]				Weight app. [kgs]
			e	a	b	l	
6-8	F349101	1,12	51	27	37	78	0,25
8-8	F349201	2,00	65	34	45,5	100	0,50
10-8	F349301	3,15	81	43	56	124	0,93
13-8	F349401	5,30	106	56	73	162	2,03
16-8	F349501	8,00	130	68	88	193	3,60
20-8*	F349601	12,50	161	85	109	246	6,00
22-8*	F349701	15,00	177	94	120	271	8,00
26-8	F349801	21,20	196	109	135	307	13,20
32-8	F349901	31,50	240	135	166	376	24,42

*on request

TWN 0896

Shortening Devices for Fixed Size Master Links

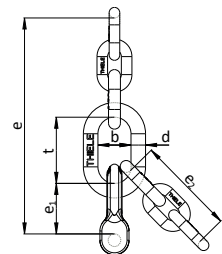

The grade 80 shortening devices for fixed size master links TWN 0896 are used in chain slings and enable the strand lengths to be adapted to the conditions of use. The manufacturing and testing requirements are based on the DIN EN 818-4, DIN EN 1677 parts 1 and 4 and the DIN 5688-3.

Trade Size	Article-No.	Working Load Limit [t]	Dimensions [mm]						Weight app. [kgs]
			e	e ₁	e ₂	d	t	b	
6-8	F0896068	1,12	137	31	60	10	46	23	0,32
8-8	F0896088	2,00	176	38	78	13	60	30	0,70
10-8	F0896108	3,15	215	46	99	16	70	35	1,40
13-8	F0896138	5,30	270	59	126	18	85	40	2,60
16-8	F0896168	8,00	326	76	150	22	100	50	4,50
18-8	F0896188	10,00	347	79	168	22	100	50	6,20
22-8	F0896228	15,00	450	100	210	32	140	70	12,00

Special Chain Coupling Links

The grade 80 special chain couplings TWN 0861 are used as end fittings in chain slings. The clevis design enables the direct attachment to the lifting chain. The special chain couplings may also be mounted directly on straps and traverses.

The manufacturing and testing requirements are based on the DIN EN 1677-1.

Trade Size	Article-No.	Working Load Limit [t]	Dimensions [mm]						Weight app. [kgs]
			e	d	c	f	b ₁	b ₂	
10-8	F30601	3,15	65	16	32	37	21	47	0,58
13-8	F30611	5,30	83	20	40	49	27	62	1,17
16-8	F30621	8,00	100	24	48	57	34	76	2,13
18-8	F30631	10,00	116	30	60	64	42	97	3,90

TWN 0861

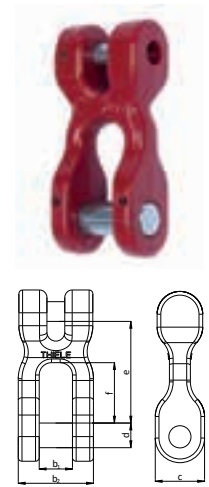

Chain Coupling Links with Bolts, Nut and Pin

The grade 80 chain couplings with bolts, nut and roll pin TWN 0862 are used as end fittings in chain slings. The clevis design enables the direct attachment to the lifting chain. The chain couplings may also be mounted directly on straps and traverses.

The manufacturing and testing requirements are based on the DIN EN 1677-1.

Trade Size	Article-No.	Working Load Limit [t]	Dimensions [mm]						Weight app. [kgs]
			e	d	c	f	b ₁	b ₂	
10-8	F30600	3,15	65	16	32	37	21	47	0,66
13-8	F30610	5,30	83	20	40	49	27	62	1,31
16-8	F30620	8,00	100	24	48	57	34	76	2,33
18-8	F30630	10,00	116	30	60	64	42	97	4,29

TWN 0862

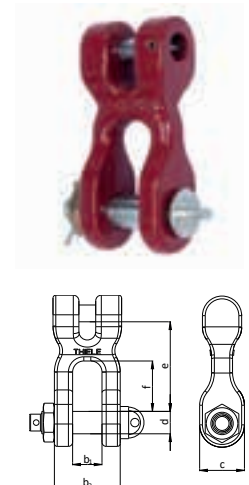

Special Bolt Shackles

The Grade 80 special shackles with bolt TWN 0870 are used as end fittings in chain slings. The shackles can be mounted directly on straps and traverses. The dimensions of the special shackles comply with DIN 82101.

The manufacturing and testing requirements are based on DIN EN 1677-1.

Trade Size	Article-No.	Trade Size [DIN 82101]	Working Load Limit [t]	Dimensions [mm]						Weight app. [kgs]
				h ₁	d ₁	d ₂	d ₄	b ₁	b ₂	
10-8	F30311	1	3,15	49	15	32	16	21	47	0,35
13-8	F30321	1,6	5,30	61	19	40	20	27	61	0,71
16-8	F30331	2,5	8,00	73	23	48	24	33	75	1,26
18/20-8	F30341	4	12,50	91	29	60	30	41	96	2,60
22-8	F30351	5	15,00	111	33	72	36	47	107	4,00
26-8	F30361	6	21,20	120	37	78	39	53	121	5,70
28-8	F30371	8	25,00	140	41	90	45	60	136	10,00
32-8	F30381	10	31,50	147	45	96	48	66	150	10,50
36-8	F30391	12	40,00	158	50	104	52	73	167	13,90
40-8	F30401	16	50,00	185	55	120	60	81	185	20,50
45-8	F30411	20	63,00	211	61	136	68	90	206	28,09

TWN 0870

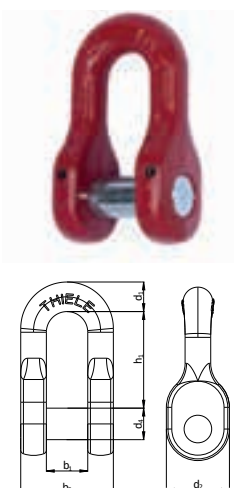

TWN 0871

Bolt Shackles Type C with Nut and Roll Pin

The grade 80 shackles type C with bolt, nut and roll pin TWN 0871 are used as end fittings in chain slings. The shackles can be mounted directly on straps and traverses. The dimensions of the shackles type C comply with the DIN 82101. The manufacturing and testing requirements are based on the DIN EN 1677-1.

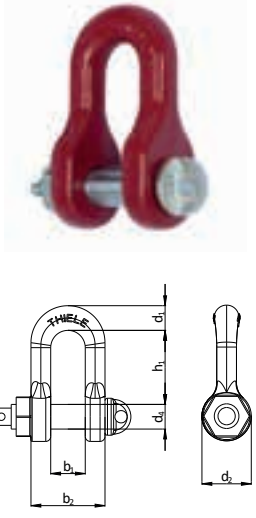

Trade Size	Article-No.	Trade Size [DIN 82101]	Working Load Limit [t]	Dimensions [mm]						Weight app. [kgs]
				h ₁	d ₁	d ₂	d ₄	b ₁	b ₂	
6-8*	Z04147	0,4	1,12	30	10	20	10	14	30	0,10
8-8	Z04145	0,6	2,00	33	12	24	12	16	37	0,20
10-8	F30310	1	3,15	49	15	32	16	21	47	0,42
13-8	F30320	1,6	5,30	61	19	40	20	27	61	0,84
16-8	F30330	2,5	8,00	73	23	48	24	33	75	1,49
18/20-8	F30340	4	12,50	91	29	60	30	42	96	3,10
22-8	F30350	5	15,00	111	33	72	36	47	107	4,50
26-8	F30360	6	21,20	120	37	78	39	53	121	6,30
28-8	F30370	8	25,00	140	41	90	45	60	136	10,10
32-8	F30380	10	31,50	147	45	96	48	66	150	12,30
36-8	F30390	12	40,00	158	50	104	52	73	167	15,23
40-8	F30400	16	50,00	185	55	120	60	81	185	22,20
45-8	F30410	20	63,00	211	61	136	68	90	206	30,86

*Finish: electro galvanized, welded on nut

TWN 0897

Special Coupling Shackles with Bolt, Nut and Roll Pin

The grade 80 special coupling shackles with bolt, nut and roll pin TWN 0897 are used as end fittings in chain slings. The clevis design enables the direct attachment to the lifting chain. The special coupling shackles can also be mounted directly on straps and traverses. The manufacturing and testing requirements are based on the DIN EN 1677-1.

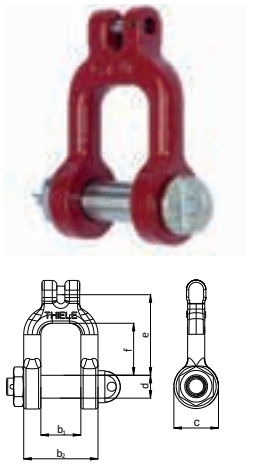

Trade Size	Article-No.	Working Load Limit [t]	Dimensions [mm]						Weight app. [kgs]
			e	d	c	f	b ₁	b ₂	
6-8	F30586	1,12	70	20	39	46	35	65	0,68
8-8	F30596	2,00	70	20	40	46	35	65	0,77

Chain Tensioners

TWN 1450

Chain Tensioners with Toggle

The grade 80 chain tensioners with toggle TWN 1450 are used as tensioning elements in lashing chains. The chain tensioners can also be used in chain slings for stepless adjustment of the strand lengths when lifting loads. The manufacturing and testing requirements are based on the DIN EN 1677-1.

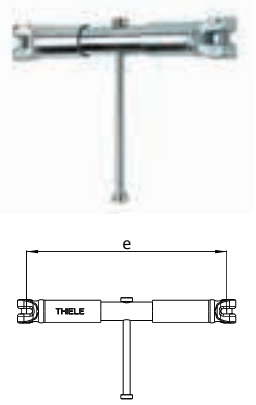

Trade Size	Article-No.	Working Load Limit [t]	Normal straight load [daN]	Lashing Capacity (LC) [daN]	Dimensions [mm]			Weight app. [kgs]
					e _{max}	e _{min}	lift	
8-8	F34179	2,00	1.800	4.000	345	270	75	2,10
10-8	F34199	3,15	2.200	6.300	375	275	100	2,70
13-8	F34189	5,30	2.600	10.000	460	330	130	4,00

If the products are initially used for lifting, e.g. internal transport, up to the load capacity, they can still be used as lashing products. If lifting products are used for lashing, they may no longer be used for lifting anymore!

Chain Tensioners/ Special Sling Components

Chain Tensioners with Ratchet

The grade 80 chain tensioners with ratchet TWN 1451 are used as tensioning elements in lashing chains. The chain tensioners can also be used in chain slings for stepless adjustment of the strand lengths when lifting loads. The manufacturing and testing requirements are based on the DIN EN 1677-1.

Trade Size	Article-No.	Working Load Limit [t]	Normal straight load [daN]	Lashing Capacity (LC) [daN]	Dimensions [mm]			Weight app. [kgs]
					e _{max}	e _{min}	lift	
8-8	F34175	2,00	1.800	4.000	345	270	75	2,50
10-8	F34195	3,15	2.200	6.300	375	275	100	3,50
13-8	F34185	5,30	2.600	10.000	460	330	130	5,00

If the products are initially used for lifting, e.g. internal transport, up to the load capacity, they can still be used as lashing products. If lifting products are used for lashing, they may no longer be used for lifting anymore!

TWN 1451

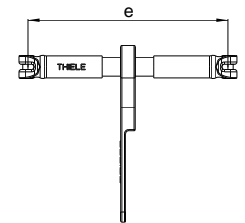

Chain Tensioners with Toggle (Large Lift)

The grade 80 chain tensioners with toggle TWN 1452 are used as tensioning elements in lashing chains. The chain tensioners can also be used in chain slings for stepless adjustment of the strand lengths when lifting loads. The chain tensioners have a particularly large lift. The chain tensioner with ratchet and trapezoidal thread achieve a high pretensioning force with little force impact. This property is of fundamental importance when lashing down, as the level of the pretensioning force contributes to load securing. The manufacturing and testing requirements are based on the DIN EN 1677-1.

Trade Size	Article-No.	Working Load Limit [t]	Normal straight load [daN]	Lashing Capacity (LC) [daN]	Dimensions [mm]			Weight app. [kgs]
					e _{max}	e _{min}	lift	
13-8	F341871	5,30	2.600	10.000	675	445	230	7,20
16-8	F34197	8,00	3.100	16.000	830	550	280	11,80

If the products are initially used for lifting, e.g. internal transport, up to the load capacity, they can still be used as lashing products. If lifting products are used for lashing, they may no longer be used for lifting anymore!

TWN 1452

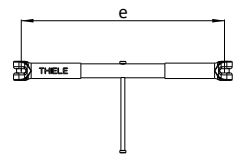

Special Sling Components

Ring Shackles

The grade 80 ring shackles TWN 0812 are used to connect lifting chains with sling components to assemble chain slings. The manufacturing and testing requirements are based on the DIN EN 1677-1.

Trade Size	Article-No.	Working Load Limit [t]	Dimensions [mm]				Weight app. [kgs]
			e	d ₁	d ₂	b	
6-8	F31700	1,12	31	17	39	8	0,10
8-8	F31710	2,00	37	21	50	11	0,23
10-8	F31720	3,15	47	26	62	14	0,46
13-8	F31730	5,30	59	33	79	18	0,87
16-8	F31740	8,00	77	42	100	23	1,60
18-8	F31750	10,00	79	47	111	25	2,50
22-8	F31760	15,00	100	55	136	31	3,80

TWN 0812

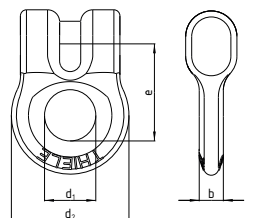

TWN 0845

Swivels

The grade 80 swivels TWN 0845 are used to assemble chain slings. The swivels enable the chain strands to be aligned without twisting. The lifting chains are assembled by using connecting links, e.g. THI-LOK®s TWN 1320. The manufacturing and testing requirements comply with the DIN EN 1677-1.

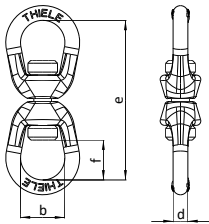

Trade Size	Article-No.	Working Load Limit [t]	Dimensions [mm]				Weight app. [kgs]
			e	d	f	b	
6-8	F34000	1,12	108	10	27	30	0,33
8-8	F34010	2,00	168	16	44	44	1,33
10-8	F34020	3,15	168	16	44	44	1,33
13-8	F34030	5,30	184	19	46	51	2,10
16-8	F34040	8,00	252	25	66	64	4,45

TWN 0882

Balancers

The grade 80 balancers TWN 0882 are used for even load distribution in multi-leg chain slings. A length compensation of different strand lengths is achieved. The manufacturing and testing requirements are based on the DIN EN 1677-1.

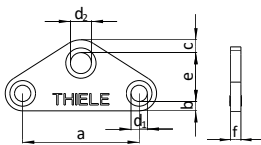

Trade Size	Article-No.	Working Load Limit [t]		Breaking Force [kN] min.	Dimensions [mm]						Weight app. [kgs]	
		$0^\circ < \beta \leq 45^\circ$	$45^\circ < \beta \leq 60^\circ$		e	a	d ₁	d ₂	b	c		f
6-8	F48300	1,60	1,12	71	42	100	14	18	8	11	10	0,40
8-8	F48303	2,80	2,00	124	56	130	18	22	10	15	12	0,80
10-8	F48306	4,25	3,15	200	70	160	22	28	13	19	15	1,50
13-8	F48309	7,50	5,30	340	91	210	28	40	16	25	20	3,40
16-8	F48312	11,20	8,00	490	110	260	36	42	20	30	25	6,60
18-8	F48313	14,00	10,00	628	130	290	40	54	23	34	25	8,40
20-8	F48322	17,00	12,50	785	130	300	42	54	25	35	30	10,90
22-8	F48315	21,20	15,00	950	140	330	46	56	28	39	35	15,20
26-8	F48319	30,00	21,20	1.300	170	390	54	66	33	46	40	24,70
32-8	F48321	45,00	31,50	1.960	210	480	68	80	40	56	50	47,40
32-8	F48325	45,00	31,50	1.960	200	700	68	80	38	54	50	63,62

TWN 0892

Key Hooks

The grade 80 key hooks TWN 0892 are used in chain slings as end fittings, predominantly for the transportation of metal sheets with keyhole openings. The manufacturing and testing requirements are based on the DIN EN 1677-1.

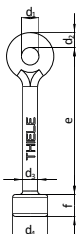

Trade Size	Article-No.	Working Load Limit [t]	Dimensions [mm]					Weight app. [kgs]	
			e	d ₁	d ₂	d ₃	d ₄		f
10-8	F34250	3,15	168	17	20	17	40	25	0,72

Special Sling Components

Isolation Assemblies

The grade 80 isolation assemblies TWN 0893 are used for the transportation of components that require isolation to the crane hook. They isolate an electrical current flow up to a maximum of 1,000 volts. The manufacturing and testing requirements are based on the DIN EN 818-4.

Trade Size	Article-No.	Working Load Limit [t]	Dimensions [mm]							Weight app. [kgs]
			e	d	c	b	g	t	h	
6-8	F08904	1,12	310	18	17	70	24	130	20	1,70
8-8	F08912	2,00	333	18	22	70	30	130	25	2,10
10-8	F08898	3,15	376	18	28	70	37	130	32	3,25
13-8	F08899	5,30	430,5	22	35	90	42	160	39	5,20

TWN 0893

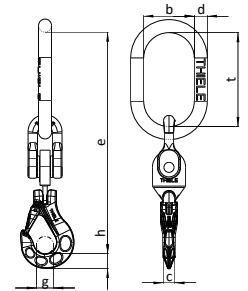

T-Handle Chains

The grade 80 T-handle chains TWN 0894 are predominantly used in civil engineering for the vertical transport of sheet piles. The manufacturing and testing requirements are based on the DIN EN 818-4.

Trade Size	Article-No.	Working Load Limit [t]	Dimensions [mm]						Weight app. [kgs]
			l	d	h	b	a	t	
10-8	F08811	1,60	405,5	13	14,5	30	95	60	1,70
10-8	F08812	1,60	675,5	13	14,5	30	95	60	2,30

TWN 0894

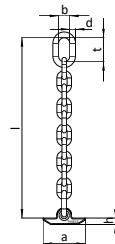

Magnet Chain Slings

Magnet sling chains according to TWN 0601 are usually being fixed to magnets.

After the magnet sling chain is being attached to the crane hook, it is possible to lift and transport magnetic material like e.g. steel scrap.

The design of the magnetic sling chains is based on ASTM A906/A906M. The dimensions, the working load limit and the manufacturing and testing requirements of the chain slings are based on the ASTM A391/A391M. The dimensions of the connecting or intermediate links type B comply with the DIN 5688-3.

Trade Size	Article-No.	Working Load Limit $0^\circ < \beta \leq 30^\circ$ [t]	Reach e [mm]		D-Link [mm]			Master-Link [mm]			Weight app. [kgs]
			$\alpha = 90^\circ$ $\beta = 0^\circ$	$\alpha = 60^\circ$ $\beta = 30^\circ$	d_1	t_1	b_1	d_2	t_2	b_2	
16-8	F08945	21,30	828	752	45	260	155	20	90	45	23,70
20-8	F08946	33,40	940	849	51	260	155	22	100	50	35,50
22-8	F08947	40,25	1.002	909	57	300	165	26	120	60	46,00
26-8	F08948	56,25	1.126	1.015	57	300	165	32	140	70	64,00
32-8	F08961	85,20	1.362	1.224	63	330	165	40	180	90	109,00

TWN 0601

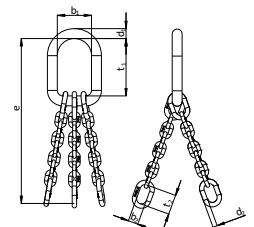



TWN 1400

Lashing Chains with Tensioner

The grade 80 lashing chains with toggle and shortenable lashing chains TWN 1400 have a standard length of 3,5 m and are used for heavy-duty lashing applications. The chain tensioners with toggle and trapezoidal thread achieve a high pretensioning force with little force impact. This property is of fundamental importance when lashing down, as the level of the pretensioning force contributes to load securing. The manufacturing and testing requirements are based on the DIN EN 12195-3.



Trade Size	Article-No.	Lashing Capacity (LC) under straight load [daN] max.	Weight app. [kgs]
8-8	F34171	4.000	8,50
10-8	F34172	6.300	12,50
13-8	F34173	10.000	21,00
16-8	F34174	16.000	37,70

Other lengths available on request.

TWN 1401

Lashing Chains with Ratchet

The grade 80 lashing chains with ratchet and shortenable lashing chains TWN 1401 have a standard length of 3,5 m and are used in the heavy-duty area for lashing loads in road traffic. The chain tensioners with ratchet and trapezoidal thread achieve a high pretensioning force with little force impact. This property is of fundamental importance when lashing down, as the level of the pretensioning force contributes to load securing. The manufacturing and testing requirements are based on the DIN EN 12195-3.



Trade Size	Article-No.	Lashing Capacity (LC) under straight load [daN] max.	Weight app. [kgs]
8-8	F34171R	4.000	8,50
10-8	F34172R	6.300	12,50
13-8	F34173R	10.000	21,00

Other lengths available on request.

Spare Parts and Accessoires

Spare Part Sets for Clevis Design

The spare part sets TWN 0904/0 consist of a bolt and dowel pin and are suitable for THIELE products with the grade 80 fixed size clevis design.

Trade Size	Article-No.	Packing Units	Weight app. [kgs]
6-8	F48694	1 set	0,01
8-8	F48352	1 set	0,01
10-8	F48355	1 set	0,03
13-8	F48358	1 set	0,07
16-8	F48361	1 set	0,11
18-8	F48364	1 set	0,20
20-8	F48369	1 set	0,26
22-8	F48367	1 set	0,31
26-8	F48373	1 set	0,50
32-8	F48371	1 set	0,91

TWN 0904/0



Spare Part Sets for Shackles

The spare part sets TWN 0905 / 0906 consist of a bolt and 2 dowel pins and are suitable for grade 80 coupling shackles TWN 0861 and bolt shackles TWN 0870.

Trade Size	Article-No.	Packing Units	Weight app. [kgs]
10-8	F48036	1 set	0,07
13-8	F48039	1 set	0,14
16-8	F48042	1 set	0,25
18/20-8	F48045	1 set	0,44
22-8	F48048	1 set	0,78
26-8	F48051	1 set	1,05
28-8	F48054	1 set	1,60
32-8	F48057	1 set	2,02
36-8	F48060	1 set	2,60
40-8	F48063	1 set	3,89

TWN 0905 / 0906



TWN 0920 - 0922 Spare Part Sets for Sling Hooks



The spare part sets TWN 0920 - 0922 consist of a safety latch, spring and a semi-tubular rivet and are suitable for grade 80 swivel hooks TWN 0854 and eye sling hooks TWN 0855/1.

Trade Size	Article-No.	Packing Units	Weight app. [kgs]
0,75 t	F48421	1 set	0,01
6-8	F48420	1 set	0,02
8-8	F48423	1 set	0,03
10-8	F48426	1 set	0,04
13-8	F48429	1 set	0,11
16-8	F48469	1 set	0,19
36-8	Z06163	1 set	0,80
40-8	Z06164	1 set	1,00
45-8	Z06165	1 set	1,40
50-8	Z06166	1 set	1,90

TWN 0930

Spare Part Sets for Shackles



The spare part sets TWN 0930 consist of a head bolt, nut and splint and are suitable for grade 80 chain coupling shackles TWN 0862 and shackles type C TWN 0871.

Trade Size	Article-No.	Packing Units	Weight app. [kgs]
10-8	F30451	1 set	0,13
13-8	F30461	1 set	0,25
16-8	F30471	1 set	0,36
18/20-8	F30481	1 set	0,97
22-8	F30491	1 set	1,31
26-8	F30501	1 set	1,99
28-8	F30511	1 set	2,89
32-8	F30521	1 set	3,12
36-8	F30531	1 set	4,48
40-8	F30541	1 set	6,65
45-8	F30551	1 set	8,20

TWN 0940

Identification Tags for single- and multi-leg Chain Slings



The grade 80 identification tags TWN 0940 are used to identify chain slings and provide important information for the operator. Chain slings may not be used without an identification tag.

Article-No. Single-leg	Article-No. Multi-leg	Diameter [mm]	Weight app. [kgs]
F08040 ¹⁾	F08044 ¹⁾	70	0,11
F08042 ²⁾	F08046 ²⁾	70	0,11

¹⁾ without welded ring, ²⁾ with welded ring

Spare Parts and Accessoires

Chain File

The chain file TWN 0944 is used for the documentation of carried out chain inspections.

Article-No.	Packing Units	Weight app. [kgs]
Z04575	1 pc.	0,01



TWN 0944

Assembly Kit

The assembly kit TWN 0945 is used for easy disassembly of bolts and dowel pins of clevis connections.

Article-No.	Packing Units	Weight app. [kgs]
Z03303	1 set	0,60



TWN 0945

Chain Gauge Set

The chain gauge set TWN 0946 is used to check the discard criteria of grade 80 chains.

Article-No.	Packing Units	Weight app. [kgs]
F48856	1 set	0,20



TWN 0946

Spare Part Sets for Shortening Hooks

The spare part sets TWN 0950 - 0952 consist of a locking pin, spring and knurled nut and are suitable for grade 80 shortening hooks TWN 0827/1.

Trade Size	Article-No.	Packing Units	Weight app. [kgs]
8-8	F48330	1 set	0,01
10-8	F48328	1 set	0,02
13-8	F48329	1 set	0,03
16-8	F48339	1 set	0,05
20-8	F48345	1 set	0,10



TWN 0950 - 0952

TWN 0962



Spare Part Sets for Skip Suspension Links

The spare part sets TWN 0962 consist of a safety latch, spring and dowel pins and are suitable for skip suspension links TWN 0869 (previous version).

Trade Size	Article-No.	Packing Units	Weight app. [kgs]
13/16-8	F31404	1 set	0,28

TWN 0967/0



Spare Part Sets for Self-Locking Hooks

The spare part sets TWN 0967/0 consist of a bolt and a dowel pin and are suitable for grade 80 clevis self-locking hooks TWN 0799.

Trade Size	Article-No.	Packing Units	Weight app. [kgs]
6-8	F333700	1 set	0,01
8-8	F333711	1 set	0,02
10-8	F333721	1 set	0,03
13-8	F333730	1 set	0,06
16-8	F333741	1 set	0,17
18/20-8	F0922057	1 set	0,28

TWN 0967/1



Spare Part Sets for Self-Locking Hooks

The trigger sets TWN 0967/1 consist of a retainer, spring and dowel pin and are suitable for grade 80 self-locking hooks TWN 0798 and TWN 0799.

Trade Size	Article-No.	Packing Units	Weight app. [kgs]
6-8	F329090	1 set	0,02
8-8	F329190	1 set	0,03
10-8	F329290	1 set	0,04
13-8	F329390	1 set	0,06
16-8	F329490	1 set	0,11
18/20-8 22-8	F0922056	1 set	0,18

Spare Parts and Accessoires

Spare Part Sets for Skip Suspension Hooks and Links NEW

The spare part sets TWN 0968 consist of a bolt and a roll pin and are suitable for the clevis connections of skip suspension links TWN 0869 and the skip suspension hooks TWN 1399.

Trade Size	Article-No.	Packing Units	Weight app. [kgs]
13-8	F480131	1 set	0,07
16-8	F480161	1 set	0,12

TWN 0968



Spare Part Sets for Skip Suspension Links

The spare part sets TWN 0969 consist of a forged safety latch, spring and dowel pins and are suitable for the skip suspension links TWN 0869 and TWN 1869.

Trade Size	Article-No.	Packing Units	Weight app. [kgs]
13-8/ 16-8 (G100 G80)	F314081	1 set	0,20

TWN 0969



Spare Part Sets for Skip Suspension Hooks NEW

The spare part sets TWN 0970 consist of a retainer, spring and dowel pin and are suitable for skip suspension hooks TWN 1399 and 1899.

Trade Size	Article-No.	Packing Units	Weight app. [kgs]
13-8/ 16-8 (G100 G80)	F48332	1 set	0,11

TWN 0970



Spare Part Sets for Clevis Shortening Claws NEW

The spare part sets TWN 0971 consist of a locking pin, threaded pin, spring and bearing and are suitable for the clevis shortening claws with safety pin TWN 0851/1 and TWN 1851/1.

Trade Size	Article-No.	Packing Units	Weight app. [kgs]
6-8 (G100 G80)	F483110	1 set	0,01
8-8 (G100 G80)	F483112	1 set	0,01
10-8 (G100 G80)	F483113	1 set	0,02
13-8 (G100 G80)	F483114	1 set	0,03
16-8 (G100 G80)	F483115	1 set	0,05
18-8 (G100 G80)	F483116	1 set	0,06
20-8 (G100 G80)	F483117	1 set	0,07
22-8 (G100 G80)	F483118	1 set	0,09
26-8 (G100 G80)	F483119	1 set	0,12
32-8 (G100 G80)	F483120	1 set	0,17

TWN 0971

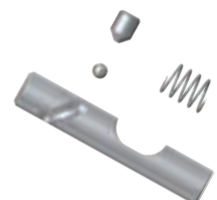

TWN 1402



Identification Tag for Lashing Chains

The identification tag TWN 0940 is used to identify lashing chains and provide important information for operation. Lashing chains may not be used without identification tag.

Article-No.	Packing Units	Weight app. [kgs]
207264	1 pc.	0,05

TWN 1908/0



Spare Part Sets for Hooks

The spare part sets TWN 1908/0 consist of a safety latch, spring and 2 dowel pins and are suitable for grade 100 sling hooks TWN 1835/1, TWN 1840/1, TWN 1841/1 and also fit the grade 80 sling hooks TWN 0835/1, TWN 0850/1, TWN 1340/1 and TWN 0858/1.

Trade Size	Article-No.	Packing Units	Weight app. [kgs]
6-8	F48731	1 set	0,05
7/8-8	F48733	1 set	0,08
10-8	F48735	1 set	0,14
13-8	F48737	1 set	0,31
16-8	F48739	1 set	0,38
18/20-8	F48743	1 set	0,71
22-8	F48745	1 set	0,89
26-8	F48748	1 set	1,41
32-8	F48749	1 set	1,77

TWN 1920



Spare Part Sets for THI-LOK® Connectors

The spare part sets TWN 1920 consist of a bolt and a clamping bush and are suitable for connecting links THI-LOK® TWN 1320.

Trade Size	Article-No.	Packing Units	Weight app. [kgs]
18-8	F48615	1 set	0,19
20-8	F48617	1 set	0,31
22-8	F48619	1 set	0,32
26-8	F48622	1 set	0,53
32-8	F48625	1 set	0,95
36-8	NEW F486224	1 set	1,65
40-8	NEW F486224	1 set	1,65

THIELE Design Key

Mounted chain slings

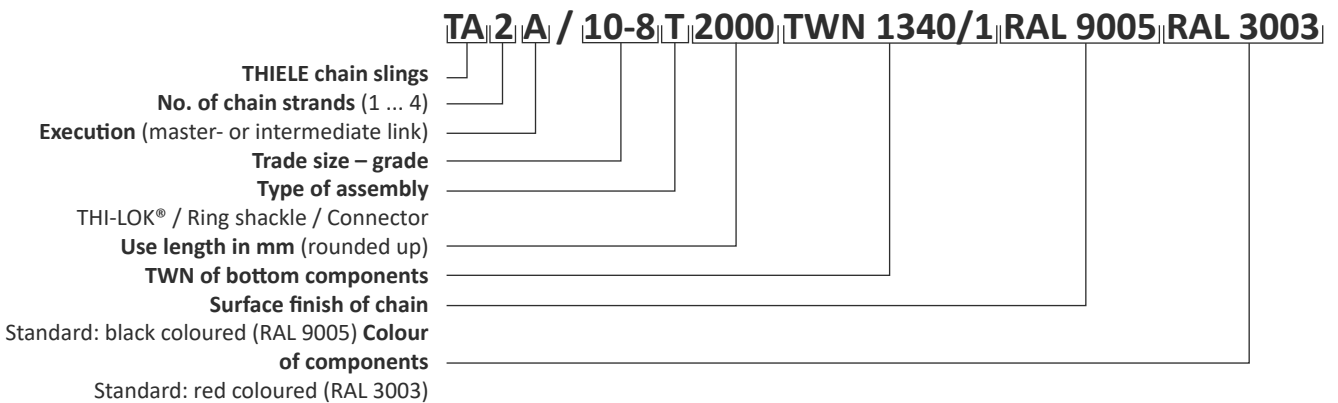

Please always indicate the THIELE key design in case of order.

Example (Picture in the middle): TA 2 A / 10-8 ____ TWN 0856 (RAL 9005, RAL 3003)

Complement to THIELE key design for slings with shortening components:

Key design as above	+1 VK	Shortening claw with pin coupling (TWN 0851)
Key design as above	+1 VE/VK	Shortening device (TWN 0896) plus Shortening claws (TWN 0851)
Key design as above	+1 VH	Shortening hook (TWN 0827)
Key design as above	+1 VE/VH	Shortening device (TWN 0896) plus Shortening hook (TWN 0827)
Key design as above	+1 VHS	Shortening hook with pin coupling (TWN 0827/1)
Key design as above	+1 VEA/VHS	Shortening device (TWN 0896) plus Shortening hook with pin coupling (TWN 0827/1)
		No. of shortenings (only 2 legs off)

Table of available components for mounted chain slings

Available fittings for standard sling chains

Master Link	... TWN 1313	Intermediate Link	... TWN 0795
Master Link for single leg w. Pin Coupling	... TWN 0820		
Suspension Shackle for Skips	... TWN 0869		
Chain Coupling Bolt Shackle	... TWN 0862	Special Chain Coupling Shackle	... TWN 0861
Special Coupling Shackle	... TWN 0897	Foundry or Container Hook with Pin Coupling	... TWN 0859
Foundry Hook Cont. or Cont. Eye Hook	... TWN 0856	Ringshackle	... TWN 0812
Bolt Shackle	... TWN 0871		
Sling Hook w. Pin Coupl. and Safety Latch	... TWN 1340/1	Clevis Sling Hooks with Safety Latch	... TWN 0858/1
	... TWN 0835/1		
Self-locking Eye Hook	... TWN 0798	Self-locking clevis Hook	... TWN 0799
Special Chain Shackle	... TWN 0870	THI-LOK®	... TWN 1320
Shortening Hook with Pin Coupling	... TWN 0827	Swivel Hook with Latch	... TWN 0854
Shortening Hook w. Pin Coupling a. Safety Latch	... TWN 0827/1	Swivel	... TWN 0845

Endless Chains



Type K11



Type K12



Type K22

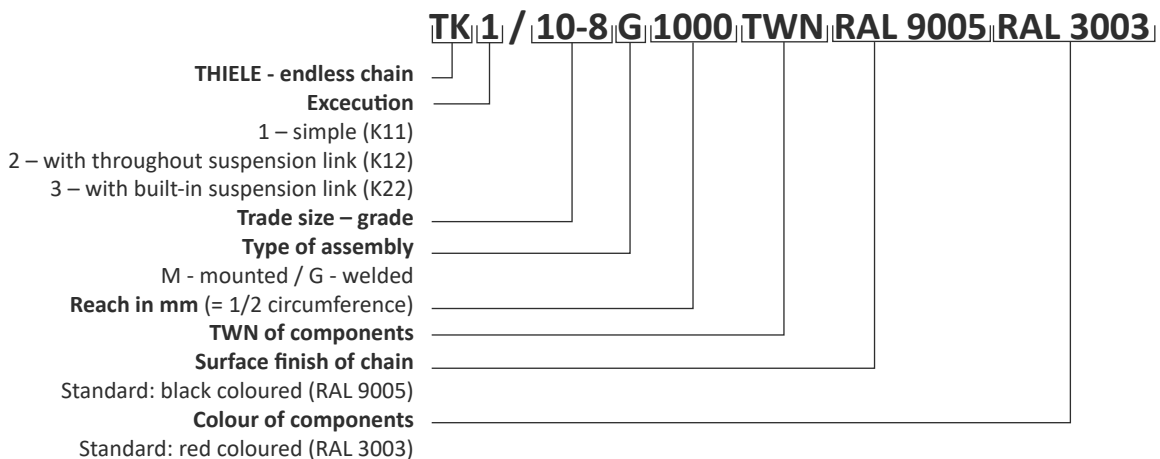

Please always indicate the THIELE key design in case of order.

Example: TK 1 / 10-8 G 1000 RAL 9005 (Endless chain Type K11 with black coloured chain)

Examples for the THIELE Design Key

Type Sling Chain	No. of loops	Execution	/	Trade Size	Type of Assembly	Reach [mm]	Component [TWN]	Surface Finish		Plant Standard [TWN]
								Chain [RAL-No.]	Components [RAL-No.]	
TA	1	A	/	---	T	-----	1313	-----	-----	0449
TA	1	A	/	---	T	-----	1340/1	-----	-----	0450/1
TA	1	A	/	---	T	-----	0854	-----	-----	0454
TA	1	A	/	---	T	-----	0856	-----	-----	0456
TA	1	A	/	---	T	-----	0870	-----	-----	0458
TA	1	A	/	---	T	-----	0871	-----	-----	0459
TA	1	A	/	---	T	-----	0859	-----	-----	0460
TA	1	A	/	---	T	-----	0861	-----	-----	0461
TA	1	A	/	---	T	-----	0862	-----	-----	0462
TA	1	A	/	---	T	-----	0858/1	-----	-----	0476/1
TA	2	A	/	---	T	-----	1313	-----	-----	0529
TA	2	A	/	---	T	-----	0835/1	-----	-----	0530/1
TA	2	A	/	---	T	-----	0854	-----	-----	0534
TA	2	A	/	---	T	-----	0856	-----	-----	0536
TA	2	A	/	---	T	-----	0858/1	-----	-----	0566/1
TA	2	A	/	---	T	-----	0870	-----	-----	0538
TA	2	A	/	---	T	-----	0871	-----	-----	0539
TA	2	A	/	---	T	-----	0859	-----	-----	0540
TA	2	A	/	---	T	-----	0861	-----	-----	0541
TA	2	A	/	---	T	-----	0862	-----	-----	0542
TK	1	1	/	---	M	-----	1313	-----	-----	0560
TA	2	A	/	---	T	-----	1320	-----	-----	0563
TA	4	A	/	---	T	-----	1314	-----	-----	0709
TA	4	A	/	---	T	-----	1340/1	-----	-----	0710/1
TA	4	A	/	---	T	-----	0854	-----	-----	0714
TA	4	A	/	---	T	-----	0856	-----	-----	0716
TA	4	A	/	---	T	-----	0858/1	-----	-----	0735/1
TA	4	A	/	---	T	-----	0870	-----	-----	0718
TA	4	A	/	---	T	-----	0871	-----	-----	0719
TA	4	A	/	---	T	-----	0859	-----	-----	0720
TA	4	A	/	---	T	-----	0861	-----	-----	0721
TA	4	A	/	---	T	-----	0862	-----	-----	0722
TK	2	3	/	---	M	-----	1313	-----	-----	0731
TA	4	A	/	---	T	-----	1320	-----	-----	0733



Examples for Chain Slings

1-leg Chain Slings

TWN 0449	TWN 0450/1	TWN 0455/1	TWN 0454













TWN 0456	TWN 0458	TWN 0459	TWN 0460

TWN 0461	TWN 0462	TWN 0473	TWN 0475

TWN 0477/1			

Examples for Chain Slings

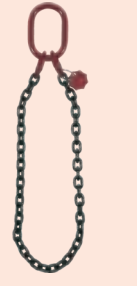
2-leg Chain Slings

TWN 0529	TWN 0530/1	TWN 0535/1	TWN 0534
			
TWN 0536	TWN 0538	TWN 0539	TWN 0540
			
TWN 0541	TWN 0542	TWN 0545	TWN 0560
			
TWN 0563	TWN 0567/1		
			



Examples for Chain Slings

4-leg Chain Slings

TWN 0709	TWN 0710/1	TWN 0715/1	TWN 0714
TWN 0716	TWN 0718	TWN 0719	TWN 0720
TWN 0721	TWN 0722	TWN 0730	TWN 0731
TWN 0733	TWN 0736/1		

A large offshore oil rig is shown against a clear blue sky. The rig has several tall, white, spiral-patterned chimneys and a complex network of yellow and blue metal structures. A large yellow crane is visible on the right side of the rig. The rig is situated over a body of blue water.

THIELE OFFSHORE LIFTING PRODUCTS

DNV-type approved Components

Offshore Components

In the Marine and Offshore industry, lifting chains are exposed to rough environmental conditions under strong dynamic loads. For this special application, THIELE as an authorized and certified manufacturer, supplies special calibrated welded lifting chains according to the DNV-ST-E271.

Our products meet the highest quality standards and are certified by the DNV.



TWN 0805 Offshore Lifting Chains



The grade 80 lifting chains TWN 0805 are made from CrNiMo alloy steel and are used to assemble chain slings and lashing chains. The max. application temperature is 400°C. The manufacturing and testing requirements of these high-quality round steel chains are based on the DIN EN 818-2 and on the German Statutory Accident Insurance test principle GS-HM 37.

Trade Size	Article-No.				Working Load Limit [t]	Nominal Size d_n [mm]	Pitch p_n [mm]	Inside Width w_3 [mm] min.	Outside Width w_2 [mm] max.	Weight app. [kgs/m]
	Self-coloured	RAL 9005	Corrothiel	Electro galvanized						
6-8	F01452	F01453	F01454	F01448	1,12	6	18	7,80	22,20	0,82
7-8	F01458	F01459	F01457	F014601	1,50	7	21	9,50	25,90	1,10
8-8	F01464	F01465	F01429	F01433	2,00	8	24	10,90	29,60	1,46
10-8	F01469	F01470	F01450	F01445	3,15	10	30	13,00	37,00	2,26
13-8	F01474	F01475	F01476	F014781	5,30	13	39	17,40	48,10	3,76
16-8	F01479	F01480	F01487	F014821	8,00	16	48	20,80	59,20	5,70
18-8	F01484	F01485	F04580	F01484G	10,00	18	54	23,40	66,60	7,10
20-8	F01494	F01495	F04606	F014944	12,50	20	60	26,00	74,00	9,00
22-8	F01499	F01500	F04629	F015111	15,00	22	66	28,60	81,40	10,90
26-8	F01514	F01515	F04695	*	21,20	26	78	33,80	96,20	15,20
28-8	F01519	F01520	F01521	–	25,00	28	84	36,40	104,00	17,60
32-8	F01524	F01525	F01526	F01527	31,50	32	96	41,60	118,00	23,00
36-8	F01529	F01530	F04814	–	40,00	36	108	46,80	133,00	29,00
40-8	F01534	F01535	F04838	–	50,00	40	120	52,00	148,00	36,00
45-8	F01539	F01540	F04889	–	63,00	45	135	58,50	167,00	45,50
50-8	F01545	F01546	F04900	–	80,00	50	150	65,00	185,00	56,00
56-8	F01555	F01556	F04908	–	100,00	56	168	72,80	207,00	72,50
63-8	–	F01566	–	–	125,00	63	190	81,90	233,00	89,00
71-8	–	F01598	–	–	160,00	71	210	92,30	263,00	113,00

DNV-type approved Components

Offshore Master Link Assemblies for Wire Rope Slings

The grade 80 master link assemblies TWN 0797 are used to assemble 3- and 4-leg wire rope slings for offshore applications. The extra-large intermediate links enable easy assembly of the sling ropes. The manufacturing and testing requirements are based on the DIN EN 1677 parts 1 and 4. The dimensions comply to the DIN 5688-3. The assemblies are DNV-type approved.

TWN 0797

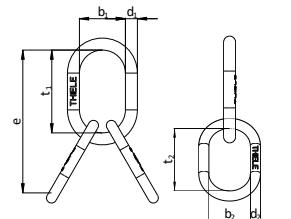

Trade Size	Article-No.	Working Load Limit ($\beta = 45^\circ$) SF= 1:4 [t]	Dimensions [mm]							Weight app. [kgs]
			e	d ₁	t ₁	b ₁	d ₂	t ₂	b ₂	
26/22	F0797268	7,90	340	26	180	100	22	160	90	5,40
32/26	F0797328	11,30	410	32	230	125	26	180	100	9,10
36/32	F0797368	16,00	480	36	250	140	32	230	125	15,10
45/36	F0797458	22,60	570	45	320	175	36	250	140	25,00
50/45	F0797508	26,80	660	50	340	190	45	320	175	42,00
56/50	F0797568	40,00	720	56	380	210	50	340	190	57,00
63/56	F0797638	50,00	810	63	430	240	56	380	210	79,00

The load capacities, manufacturing and testing requirements comply with the DNV-ST-E271 and some exceed the requirements of the DIN EN 1677-1 and EN 1677-4.



Offshore Master Links Type A

The grade 80 offshore master links TWN 0803 are used to assemble 1- and 2-leg chain slings for offshore applications. The manufacturing and testing requirements are based on the DIN EN 1677 parts 1 and 4. The dimensions comply with the DIN 5688-3. The master links can also be used to manufacture wire rope slings according to the DIN EN 13414-1. The master links are DNV-type approved.

TWN 0803

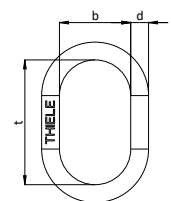

Trade Size	Article-No.	Working Load Limit [t]	Dimensions [mm]			Weight app. [kgs]
			d	t	b	
20	F0803208	4,75	20	140	80	1,10
22	F0803228	5,60	22	160	90	1,50
26	F0803268	8,00	26	180	100	2,30
32	F0803328	12,50	32	230	125	4,40
36	F0803368	16,00	36	250	140	6,20
40	F0803408	19,00	40	290	160	8,80
45	F0803458	25,00	45	320	175	12,00
50	F0803508	31,50	50	340	190	16,00
56	F0803568	40,00	56	380	210	23,00
63	F0803638	50,00	63	430	240	33,00
70	F0803708	63,00	70	470	260	44,00
80	F0803808	80,00	80	520	290	64,00

The load capacities, manufacturing and testing requirements comply with the DNV-ST-E271 and some exceed the requirements of the DIN EN 1677-1 and EN 1677-4.

TWN 0804

Offshore Intermediate Links Type B

The grade 80 offshore intermediate links TWN 0804 are used in welded type chain slings for offshore applications. The dimensions comply with the DIN 5688-3. The intermediate links are DNV-type approved. The manufacturing and testing requirements are based on the DIN EN 1677 parts 1 and 4 and DIN 5688-3.

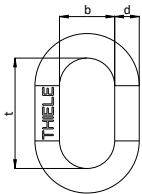

Trade Size	Article-No.	Working Load Limit [t]	Dimensions [mm]			Weight app. [kgs]
			d	t	b	
B13	F0804138	3,35	13	60	30	0,20
B16	F0804168	5,60	16	70	35	0,36
B20	F0804208	8,50	20	90	45	0,73
B22	F0804228	10,00	22	100	50	0,97
B26	F0804268	14,00	26	120	60	1,60
B28	F0804288	16,00	28	130	65	1,90
B32	F0804328	22,40	32	140	70	2,90
B36	F0804368	28,00	36	160	80	4,20
B40	F0804408	33,50	40	180	90	5,80
B45	F0804458	42,50	45	200	100	8,20
B50	F0804508	53,00	50	220	110	11,00

The load capacities, manufacturing and testing requirements comply with the DNV-ST-E271 and some exceed the requirements of the DIN EN 1677-1 and DIN EN 1677-4.

TWN 0818

Offshore Bolt Shackles Type C

The shackles type C with bolt, nut and dowel pin TWN 0818 are intended to use in "Lifting Sets" for offshore containers acc. to DNVGL-ST-E271 and are used in portable offshore units acc. to DNV-ST-E273. The manufacturing and testing requirements are based on the DIN EN 1677-1.

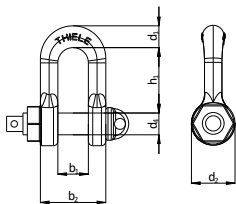

Trade Size	Article-No.	Trade Size [DIN 82101]	Working Load Limit [t]	Dimensions [mm]						Weight app. [kgs]
				h ₁	b ₁	b ₂	d ₁	d ₄	d ₂	
10-8	F30310NV	1,0	3,15	49	21	47	15	16	32	0,42
13-8	F30320NV	1,6	5,30	61	27	61	19	20	40	0,84
16-8	F30330NV	2,5	8,00	73	33	75	23	24	48	1,49
18/20-8	F30340NV	4,0	12,50	91	42	96	29	30	60	3,10
22-8	F30350NV	5,0	15,00	111	47	107	33	36	72	4,50
26-8	F30360NV	6,0	21,20	120	53	212	37	39	78	6,30
28-8	F30370NV	8,0	25,00	140	60	136	41	45	90	10,10
32-8	F30380NV	10,0	31,50	149	66	152	46	48	95	12,80
36-8	F30390NV	12,0	40,00	158	73	167	50	52	104	15,60
40-8	F30400NV	16,0	50,00	185	81	185	55	60	120	22,20
45-8	F30410NV	20,0	63,00	211	90	206	61	68	136	26,30

The load capacities, manufacturing and testing requirements comply with the DNV-ST-E271 and some exceed the requirements of the DIN EN 1677-1.



TLP

THIELE LIFTING AND LASHING POINTS

Screw- and Weld-on Type



Product Overview - Lifting Points

Pages 104-111	Lifting Points, Screw-Type				
TWN 0121	TWN 0122	TWN 0123	TWN 0127	TWN 1120	
TWN 1830	TWN 1884	TWN 1890			

Pages 112-119	Lifting Points, Weld-on Type				
TWN 0119	TWN 0124	TWN 0850/1	TWN 1908/0	TWN 0850/2	
TWN 0913	TWN 1380	TWN 0949	TWN 1490	TWN 1872	
TWN 1882	TWN 1473	TWN 1880	TWN 1477	TWN 1471	

Page 120	Hitches				
TWN 0301	TWN 0302	TWN 0304	TWN 0308	TWN 0321	
TWN 0323					

Lifting Points

Selection Criteria for Lifting Points

1. Determine the weight of the load to be lifted.



3. Determine the trade size by taking the inclination angle into consideration.

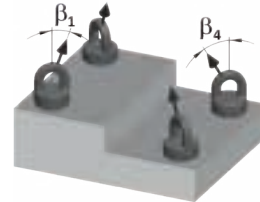

2. Determine the number of required lifting points, depending on the number of available legs of the chain slings and the number of available fitting positions (see pictographs on pages 104-107 and 112-113).

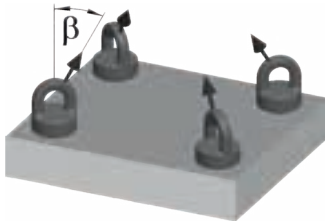

4. Select the suitable lifting point by taking the type of application and the determined working load limit under consideration.



TLP

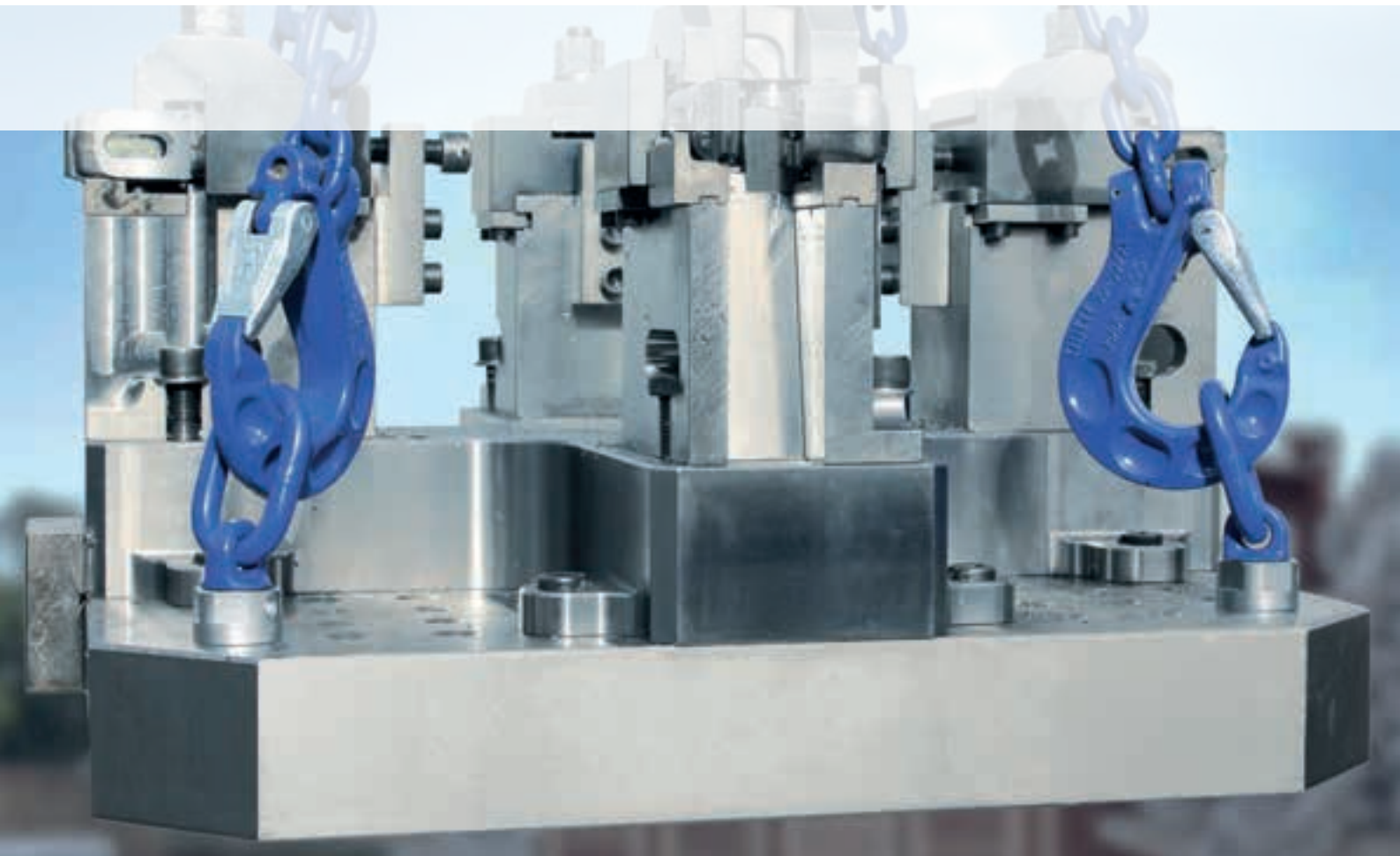



Lifting Points, Screw-Type



Working Load Limit Table for Lifting Points, Screw-Type

			TWN 0121 Swivel Lifting Points								TWN 0122 Screw-Type Lifting Points							
Application	Inclination Angle β	Number of Chain Strands	Working Load Limit [t]															
			Nominal Working Load Limit				Screw Size											
					1,12	2,0	3,15	5,3			3,15	5,3	8,0	15	21,2	25	31,5	36
					M16	M20	M24	M30			M16	M20	M30	M36	M42	M45	M56	M56
	0°	1			1,12	2,0	3,2	5,3			3,15	5,3	8,0	15	21,2	25	31,5	36
	0°	2			2,24	4,0	6,3	10,6			6,3	10,6	16	30	42,4	50	63	72
	90°	1			1,12	2,0	3,15	5,3			3,15	5,3	8,0	15	21,2	25	31,5	36
	90°	2			2,24	4,0	6,3	10,6			6,3	10,6	16	30	42,4	50	63	72
	0-45°	2			1,6	2,8	4,5	7,5			4,5	7,5	11,3	21,2	30	33,4	45,5	50,9
	45-60°	2			1,12	2,0	3,15	5,3			3,15	5,3	8,0	15	21,2	25	31,5	36
	asymmetry ¹⁾	2			1,12	2,0	3,15	5,3			3,15	5,3	8,0	15	21,2	25	31,5	36
	0-45°	3+4			2,4	4,2	6,7	11,2			6,7	11,2	17	31,8	45	53	66,8	76,4
	45-60°	3+4			1,7	3,0	4,7	8,0			4,7	8,0	12	22,5	31,8	37,5	47,3	54
	asymmetry ¹⁾	3+4			1,1	2,0	3,2	5,3			3,15	5,3	8,0	15	21,5	25	31,5	36

¹⁾ Reduced working load limit acc. to the DIN 685-5.

Lifting Points, Screw-Type

Working Load Limit Table for Lifting Points, Screw-Type











TWN 0123 Screw-Type Lifting Points					TWN 0127 Screw Type Lifting Points MDB									
														
Working Load Limit [t]														
		1,12	2	3,15						3,15	5,3			
		M16	M20	M24						M20	M24			
		1,12	2,0	3,15						3,15	5,3			
		2,24	4,0	6,3						6,3	10,6			
		1,12	2,0	3,15						3,15	5,3			
		2,24	4,0	6,3						6,3	10,6			
		1,6	2,8	4,5						4,5	7,5			
		1,12	2,0	3,15						3,15	5,3			
		1,12	2,0	3,15						3,15	5,3			
		2,4	4,2	6,7						6,7	11,2			
		1,7	3,0	4,7						4,7	8,0			
		1,12	2,0	3,15						3,15	5,3			





Lifting Points, Screw-Type



Working Load Limit Table for Lifting Points, Screw-Type

			TWN 1120 X-TITAN Lifting Points								TWN 1830 X-TREME Lifting Points																
Application	Inclination Angle β	Number of Chain Strands																									
			Working Load Limit [t]																								
Working Load Limit			0,3	0,45	0,6	1,4	2,5	3,5	6,7	8,0	0,45	0,6	1,4	2,5	3,5	5,3	8,0	10	12,5	12,5	12,5	17	17	31,5	35	40	40
Screw Size			M8	M10	M12	M16	M20	M24	M30	M36	M10	M12	M16	M20	M24	M30	M36	M42	M45	M48	M52	M56	M64	M72	M80	M90	M100
	0°	1	0,3	0,45	0,6	2,1	3,0	6,0	7,1	12,5	0,9	1,2	2,8	5,3	7	10	15	18	20	20	20	28	28	50	50	50	50
	0°	2	0,6	0,9	1,2	4,2	6,0	12	14,2	25	1,8	2,4	5,6	10,6	14	20	30	36	40	40	40	56	56	100	100	100	100
	90°	1	0,3	0,45	0,6	1,4	2,5	3,5	6,7	8,0	0,6	0,75	1,7	2,8	4,0	6,3	10	13	15	16	16	22	25	40	48	50	50
	90°	2	0,6	0,9	1,2	2,8	4,9	7,0	13,4	16	1,2	1,5	3,4	5,6	8,0	12,6	20	26	30	32	32	44	50	80	96	100	100
	0-45°	2	0,42	0,6	0,9	2,0	3,6	5,	9,5	11,3	0,9	1,0	2,4	4,0	5,7	8,9	14,1	18,2	21,2	22,6	22,6	31,1	35,3	56	68	71	71
	45-60°	2	0,3	0,5	0,6	1,4	2,5	3,5	6,7	8,0	0,6	0,75	1,7	2,8	4,0	6,3	10	13	15	16	16	22	25	40	48	50	50
	Asymmetry ¹⁾	2	0,3	0,5	0,6	1,4	2,5	3,5	6,7	8,0	0,6	0,75	1,7	2,8	4,0	6,3	10	13	15	16	16	22	25	40	48	50	50
	0-45°	3+4	0,6	1,0	1,3	3,0	5,3	7,4	14,2	17	1,3	1,6	3,6	5,9	8,5	13,4	21,2	27,3	31,8	33,9	33,9	46,7	53	85	102	106	106
	45-60°	3+4	0,5	0,7	0,9	2,1	3,8	5,3	10	12	0,9	1,1	2,6	4,2	6,0	9,5	15	19,5	22,5	24	24	33	37,5	60	72	75	75
	Asymmetry ¹⁾	3+4	0,3	0,5	0,6	1,4	2,5	3,5	6,7	8,0	0,6	0,8	1,7	2,8	4,0	6,3	10	13	15	16	16	22	25	40	48	50	50

¹⁾ Reduced working load limit acc. to DIN 685-5.

Lifting Points, Screw-Type

Working Load Limit Table for Lifting Points, Screw-Type

TWN 1884 Screw Type XKE-Points											TWN 1890 Screw Type XS-Points								
																			
Working Load Limit [t]																			
0,3	0,5	1,0	1,7	2,6	3,5	6,0	8,0	12,5	15	17		0,63	1,0	1,5	2,5	4,0	6,0	8,0	10
M8	M10	M12	M16	M20	M24	M30	M36	M42	M45	M48		M10	M12	M16	M20	M24	M30	M36	M42
0,3	0,5	1,0	1,7	2,6	3,5	6,0	8,0	11,5	13	14,5		0,6	1,0	1,7	2,5	4,0	6,0	8,0	10
0,6	1,0	2,0	3,4	5,2	7,0	12	16	23	26	29		1,3	2,0	3,4	5,0	8,0	12	16	20
0,3	0,5	1,0	1,7	2,6	3,5	6,0	8,0	11,5	13	14,5		0,6	1,0	1,7	2,5	4,0	6,0	8,0	10
0,6	1,0	2,0	3,4	5,2	7,0	12	16	23	26	29		1,3	2,0	3,4	5,0	8,0	12	16	20
0,4	0,7	1,4	2,4	3,6	4,9	8,4	11,3	16,2	18,3	20,5		0,9	1,4	2,4	3,5	5,7	8,5	11,3	14
0,3	0,5	1,0	1,7	2,6	3,5	6,0	8,0	11,5	13	14,5		0,6	1,0	1,7	2,5	4,0	6,0	8,0	10
0,3	0,5	1,0	1,7	2,6	3,5	6,0	8,0	11,5	13	14,5		0,3	1,0	1,7	2,5	4,0	6,0	8,0	10
0,6	1,0	2,1	3,6	5,5	7,0	12,7	16,9	24,3	27,5	30,7		1,3	2,1	3,6	5,3	8,5	12,7	17	21,2
0,4	0,8	1,5	2,5	3,9	5,2	9,0	12	17,2	19,5	21,7		1,0	1,5	2,6	3,8	6,0	9,0	12	15
0,3	0,5	1,0	1,7	2,6	3,5	6,0	8,0	11,5	21,7	14,5		0,6	1,0	1,7	2,5	4,0	6,0	8,0	10



TLP



Lifting Points, Screw-Type

TWN 0121

Swivel Lifting Points NEW

The screw-type rotating lifting points TWN 0121 are predominantly used in mold and tool making. The sliding disc enables a twist-free alignment of the chain strands. The eyelet allows easy assembling with other lifting components. The manufacturing and testing requirements are based on the DIN EN 1677-1.

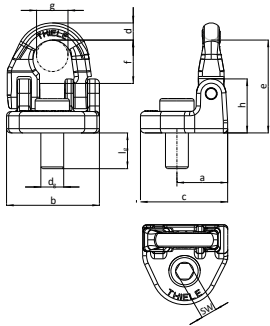

Screw Size d _g [mm]	Article-No.	Working Load Limit [t]	Thread Length l _g [mm]	Dimensions [mm]									Weight app. [kgs]
				e	f	c	b	h	g	d	SW	a	
M16 ¹⁾	F35000	1,12	25	65	30	61	65	38	22	12	12	36	0,70
M20 NEW	F350100	2,00	32	80	34	78	90	49	28	17	14	45	1,56
M24 ¹⁾	F35020	3,15	36	98	45	92	101	59	33	19	17	52	2,60
M30 ¹⁾	F35030	5,30	51	120	55	113	125	72	45	25	22	62	4,60

¹⁾ TWN 0121/1

TWN 0122

Screw-type Lifting Points

The screw-on lifting points TWN 0122 are predominantly used for the transportation of heavy moulds, tools, dies, machine elements and steel constructions. The intermediate links allow an easy assembling with other lifting components. The manufacturing and testing requirements comply with the DIN EN 1677-1.

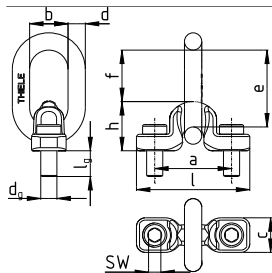

Screw Size d _g [mm]	Article-No.	Working Load Limit [t]	Thread Length l _g [mm]	Dimensions [mm]										Weight app. [kgs]
				e	f	a	b	l	d	h	t	c	SW	
M16	F35070	3,15	25	112	57	90	40	130	18	55	85	38	12	1,47
M20	F35075	5,30	36	149	80	115	50	165	22	69	115	45	14	2,70
M30	F35080	8,00	50	183	93	150	65	212	26	89	140	55	22	5,94
M36	F35095	15,00	53	217	105	175	80	255	36	112	160	72	27	11,08
M42	F35098	21,20	67	262	132	200	100	295	45	130	200	90	32	20,09
M45	F35101	25,00	67	262	132	200	100	295	45	130	200	90	32	20,55
M56	F35102	31,50	88	336	193	230	110	330	48	143	270	100	36	31,60
M56	F35285	36,00	88	336	193	230	110	330	48	143	270	100	36	31,60

Lifting Points, Screw-Type

Screw-type Lifting Points

The screw-type lifting points TWN 0123 are predominantly used for the transportation of moulds, tools, dies, machine parts and steel constructions. The intermediate links allow an easy assembling with other lifting components. The manufacturing and testing requirements comply with the DIN EN 1677-1.



Screw Size d_g [mm]	Article-No.	Working Load Limit [t]	Thread Length l_g [mm]	Dimensions [mm]							Weight app. [kgs]
				e	f	d	t	b	SW	a	
M16	F34110	1,12	30	113	52	16	70	35	46	60	0,83
M16	F34115	1,12	30	153	92	16	110	60	46	60	1,00
M20	F34120	2,00	38	113	52	16	70	35	46	60	0,87
M20	F34121	2,00	38	153	92	16	110	60	46	60	1,05
M24	F34130	3,15	35	128	67	18	85	40	46	60	1,08
M24	F34131	3,15	45	153	92	18	110	60	46	60	1,26

TWN 0123

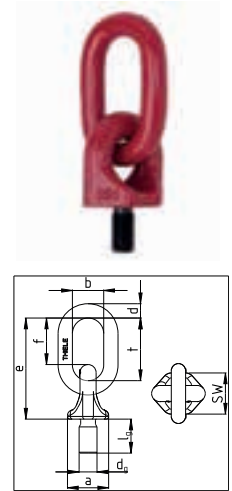

MDB Lifting Points

The screw-type lifting points TWN 0127 are predominantly used for the transportation of moulds, tools, dies, machine elements and steel constructions. The D-links enable an easy assembling to lifting components. The manufacturing and testing requirements comply with the DIN EN 1677-1.



Screw Size d_g [mm]	Article-No.	Working Load Limit [t]	Thread Length l_g [mm]	Dimensions [mm]								Weight app. [kgs]
				e	f	c	b	l	d	SW	a	
M20	F35157	3,15	39	68	48	44	48	130	18	30	90	1,10
M24	F35158	5,30	36	113	69	60	66	160	24	36	110	2,70

TWN 0127

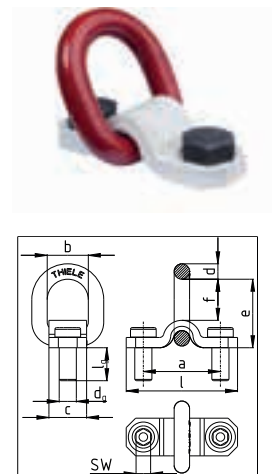

X-TITAN Lifting Points

The screw-type X-TITAN lifting points TWN 1120 are predominantly used for the transportation of moulds, tools, dies, machine elements and steel constructions. The intermediate links allow an easy assembling to other lifting components. The manufacturing and testing requirements are based on DIN EN 1677-1.



Screw Size d_g [mm]	Article-No.	Working Load Limit [t]	Thread Length l_g [mm]	Dimensions [mm]								Weight app. [kgs]
				e	f	b	t	d	h	SW	a	
M10	F34390	0,45	19	95	40	28	50	10	55	16	43	0,41
M12	F34395	0,60	24	95	40	28	50	10	55	18	43	0,43
M16	F34400	1,40	29	95	40	28	50	10	55	24	43	0,48
M20	F34410	2,50	33	115	49	34	60	12	66	30	54	0,79
M24	F34420	3,50	40	135	55	40	70	16	80	36	65	1,50
M30	F34430	6,70	52	167	66	50	85	18	101	46	85	2,98
M36	F34440	8,00	66	212	92	50	115	22	120	55	96	4,80

TWN 1120





Lifting Points, Screw-Type

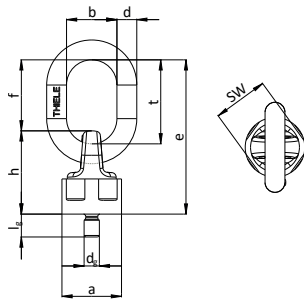

TWN 1830 X-TREME Lifting Points

The screw-type X-TREME lifting points with ball-bearing TWN 1830 are predominantly used in mold- and tool-making. The ball-bearing allows the load to be rotated and turned under load.

The intermediate link allows easy assembling to other components.

The manufacturing and testing requirements are based on the DIN EN 1677-1.



Screw Size d_g [mm]	Article-No.	Working Load Limit [t]			Thread Length l_g [mm]	Dimensions [mm]								Weight app. [kgs]
		vertical $\beta_1 = \pm 5^\circ$ Y	extreme $5^\circ < \beta_1 \leq 45^\circ$ Z	folded $5^\circ < \beta_2 \leq 105^\circ$ X		e	f	b	t	d	h	SW	a	
M10	F34306	0,90	0,45	0,60	15	101	47	33	55	13	55	36	39	0,48
M12	F34307	1,20	0,60	0,70	18	101	47	33	55	13	55	36	39	0,49
M16	F34300	2,80	1,40	1,70	20	101	47	33	55	13	55	36	39	0,50
M20	F34310	5,30	2,50	2,80	25	121	59	34	70	16	63	46	50	0,94
M20	F34312	5,30	2,50	2,80	50	121	59	34	70	16	63	46	50	1,02
M24	F34320	7,00	3,50	4,00	30	148	72	40	85	18	76	50	57	1,50
M24	F34321	7,00	3,50	4,00	90	148	72	40	85	18	76	50	57	1,68
M30	F34330	10,00	5,30	6,30	40	171	83	50	100	22	88	65	73	2,72
M36	F34340	15,00	8,00	10,00	50	179	81	50	100	22	98	70	83	3,57
M36	F34341	15,00	8,00	10,00	63	179	81	50	100	22	98	70	83	3,67
M36	F34343	15,00	8,00	10,00	70	179	81	50	100	22	98	70	83	3,80
M42	F34350	18,00	10,00	12,50	60	244	116	70	140	32	128	95	106	8,30
M45	F34353	20,00	12,50	15,00	65	244	116	70	140	32	128	95	106	8,45
M48	F34355	20,00	12,50	16,00	68	244	116	70	140	32	128	95	106	8,60
M56	F34360	28,00	17,00	22,00	78	251	116	70	140	32	135	95	116	10,08
M64	F34363	28,00	17,00	25,00	96	251	116	70	140	32	135	95	116	11,38
M72	NEW F34380	50,00	31,50	40,00	108	379	177	110	220	45	202	145	170	31,42
M80	NEW F34383	50,00	35,00	48,00	120	379	177	110	220	45	202	145	170	32,67
M90	NEW F34385	50,00	40,00	50,00	135	379	177	110	220	45	202	145	170	34,64
M100	NEW F34388	50,00	40,00	50,00	150	379	177	110	220	45	202	145	170	37,10

Variable screw lengths available up to 5 x d standard screw lengths for thread diameters M20, M24, M30 and M36.

vertical
 $\beta_1 = \pm 5^\circ$
Y



folded
 $5^\circ < \beta_2 \leq 105^\circ$
X



extreme
 $5^\circ < \beta_1 \leq 45^\circ$
Z



Lifting Points, Screw-Type

TWN 1884 XKE-Points

The screw-on XKE-Points with ball-bearing TWN 1884 are predominantly used in molds- and tool-making. The ball-bearing allows the load to be rotated and turned under load. The eccentrically positioned eye makes it easy to connect lifting equipment. The XKE-points have a multiple times higher load capacity than DIN 580-eye bolts and can be loaded in every direction. The eccentrically arranged eyelet enables an easy assembly with a standard Allen key. The manufacturing and testing requirements are based on the DIN EN 1677-1.

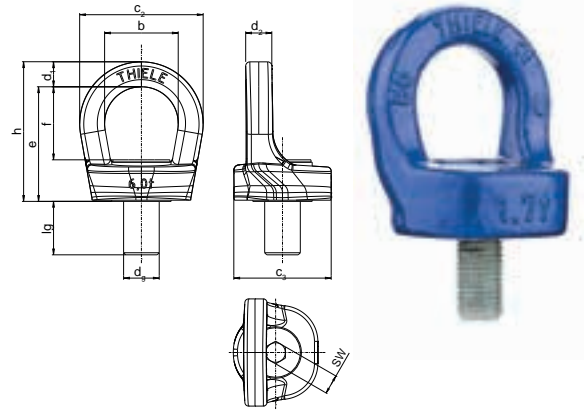

Screw Size d_g [mm]	Article-No.	Working Load Limit [t]	Thread Length l_g [mm]	Dimensions [mm]											Weight app. [kgs]
				b	c_2	c_3	e	f	h	d_1	d_2	l	SW		
M8	NEW F38005	0,30	16	26	45	37	40	26	50	9,5	9,5	8	6	0,18	
M10	NEW F38006	0,50	16	26	45	37	40	26	50	9,5	9,5	8	6	0,18	
M12	NEW F38007	1,00	18	30	51	43	47	30	57	10,5	10,5	10	8	0,29	
M16	F38010	1,70	27	38	66	56	62	38	76	14	14	13	10	0,66	
M20	F38020	2,60	33	42	74	61	70	42	86	16	16	15	12	0,99	
M24	NEW F38030	3,50	39	51	85	65	82	51	99	17	18	16	14	1,34	
M30	NEW F38040	6,00	45	62	104	82	97	62	118	21	22	20	19	2,29	
M36	NEW F38050	8,00	55	75	131	92	116	75	144	28	28	25	19	4,17	
M42	NEW F38060	11,50	64	95	173	122	142	95	181	39	39	33	22	8,89	
M45	NEW F38070	13,00	74	95	173	122	142	95	181	39	39	33	24	9,09	
M48	NEW F38080	14,50	74	95	173	122	142	95	181	39	39	33	27	9,18	

TWN 1890 XS-Points

The screw-type XS-Points TWN 1890 are predominantly used in mold making, tool making and vehicle construction. The extra large D-links enable an easy assembling to other lifting components. The bracket can be easily aligned in direction of force. The shape of the XS-Points allows the use of variable screw lengths. The manufacturing and testing requirements are based on the DIN EN 1677-1.

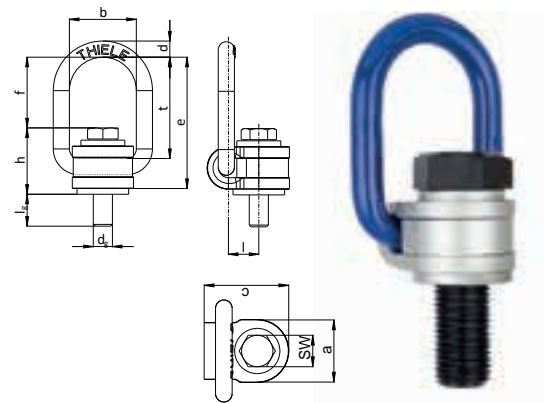



Screw Size d_g [mm]	Article-No.	Working Load Limit [t]	Thread Length l_g [mm]	Dimensions [mm]											Weight app. [kgs]
				e	f	c	l	t	b	h	d	SW	a		
M8	NEW F352398	0,30	17	71	38	43	17	53	35	35	9	-	32	0,29	
M10	F35243	0,63	17	71	37	43	17	53	35	35	9	16	32	0,29	
M12	F35244	1,00	22	71	36	43	17	53	35	36	9	18	32	0,31	
M16	F35245	1,70	28	98	46	64	25	70	50	52	13	24	48	0,96	
M20	F35246	2,50	38	98	44	64	26	70	50	54	13	30	48	1,05	
M24	F35247	4,00	40	135	70	71	28	102	58	65	16	36	50	1,69	
M30	F35249	6,00	44	149	73	88	35	110	70	75	20	46	65	3,07	
M36	F35250	8,00	64	149	70	88	35	110	70	79	20	55	67	3,55	
M42	F35251	10,00	74	191	98	106	43	145	84	93	24	65	81	6,10	
M48*	F35252	12,00	-	-	-	-	-	-	-	-	-	-	-	-	

*On request



Lifting Points, Weld-on Type

Working Load Limit Table for Lifting Points, Weld-on Type

			TWN 0119 Weld-on type Lifting Points								TWN 0124 Weld-on type Lifting Points with Springs							
Application	Inclination Angle β	Number of Chain Strands	 															
			Working Load Limits [t]															
Working Load Limit			1,1	2,0	3,15	5,3	8,0	15	32	50			1,12	2,0	3,15	5,3	8,0	
	0°	1	1,1	2,0	3,15	5,3	8,0	15	31,5	50			1,12	2,0	3,15	5,3	8,0	
	0°	2	2,2	4,0	6,3	10,6	16	30	63	100			2,24	4,0	6,3	10,6	16	
	90°	1	1,1	2,0	3,15	5,3	8,0	15	31,5	50			1,12	2,0	3,15	5,3	8,0	
	90°	2	2,2	4,0	6,3	10,6	16	30	63	100			2,24	4,0	6,3	10,6	16	
	0-45°	2	1,6	2,8	4,5	7,5	11,2	21,2	44,5	70			1,6	2,8	4,25	7,5	11,2	
	45-60°	2	1,1	2,0	3,15	5,3	8,0	15	31,5	50			1,12	2,0	3,15	5,3	8,0	
	asymmet.	2	1,1	2,0	3,15	5,3	8,0	15	31,5	50			1,12	2,0	3,15	5,3	8,0	
	0-45°	3+4	2,4	4,2	6,7	11,2	17	31,5	67	106			2,36	4,25	6,7	11,2	17	
	45-60°	3+4	1,7	3,0	4,7	8,0	12	22,4	47,5	75			1,7	3,0	4,75	8,0	11,8	
	asymmet.	3+4	1,12	2,0	3,15	5,3	8,0	15	31,5	50			1,12	2,0	3,15	5,3	8,0	

Lifting Points, Weld-on Type

Working Load Limit Table for Lifting Points, Weld-on Type

TWN 1872 Lifting Points with two Weld-on Brackets					TWN 1882 COMPACT Lifting Points with Spring							
												
Working Load Limit [t]												
			4,0	6,7				1,5	2,5	4,0	6,7	10
			4,0	6,7				1,5	2,5	4,0	6,7	10
			8,0	13,4				3,0	5,0	8,0	13,4	20
			4,0	6,7				1,5	2,5	4,0	6,7	10
			8,0	13,4				3,0	5,0	8,0	13,4	20
			5,6	9,5				2,1	3,5	5,6	9,4	14
			4,0	6,7				1,5	2,5	4,0	6,7	10
			4,0	6,7				1,5	2,5	4,0	6,7	10
			8,5	14,2				3,15	5,25	8,4	14,1	21
			6,0	10,1				2,25	3,75	6,0	10,1	15
			4,0	6,7				1,5	2,5	4,0	6,7	10





TWN 0119

Weld-on type Lifting Points

The weld-on lifting points TWN 0119 are used for universal lifting, moving and lashing of loads. The lifting points are often welded to machine frames, steel structures, lifting beams and housings. The manufacturing and testing requirements are based on DIN EN 1677-1.

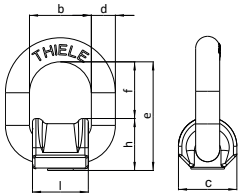

Trade Size	Article-No.	Working Load Limit [t]	Lashing Capacity (LC) [daN]	Dimensions [mm]							Weight app. [kgs]
				e*	f*	c	l	b	h	d	
6-8	F35103	1,12	2.200	59	31	32	32	36	28	12	0,24
8-8	F35113	2,00	4.000	69	36	38	38	42	33	14	0,46
10-8	F35123	3,15	6.300	85	46	45	44	48	38	18	0,72
13-8	F35133	5,30	10.600	120	69	60	60	66	51	24	1,93
16-8	F35143	8,00	16.000	127	66	68	65	72	61	28	2,67
22-8	F35163	15,00	-	178	98	96	109	120	80	39	8,09
32-8	F35183	31,50	-	292	174	145	165	180	118	56	27,30
40-8	F35193	50,00	-	371	223	186	210	230	145	72	60,00

*e- and f-Dimension vertical to the welding level.

TWN 0124

Weld-on type Lifting Points with Spring

The weld-on lifting points with spring TWN 0124 are used for universal lifting, moving and lashing of loads. The lifting points are often welded onto machine frames, steel constructions, lifting beams and housings. The D-ring is being held in position by a spring. The manufacturing and testing requirements are based on DIN EN 1677-1.

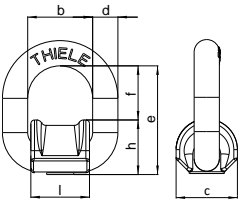

Trade Size	Article-No.	Working Load Limit [t]	Lashing Capacity (LC) [daN]	Dimensions [mm]							Weight app. [kgs]
				e*	f*	c	l	b	h	d	
6-8	F35107	1,12	2.200	57	29	32	32	36	28	12	0,24
8-8	F35110	2,00	4.000	67	34	38	38	42	33	14	0,46
10-8	F35124	3,15	6.300	81	43	45	44	48	38	18	0,72
13-8	F35139	5,30	10.600	117	66	60	60	66	54	24	1,61
16-8	F35144	8,00	16.000	122	61	68	65	72	61	28	2,67

*e- and f-Dimension vertical to the welding level.

TWN 0850/1

Weld-on Hooks

The weld-on hooks TWN 0850/1 are primarily welded to earth-moving machines, buckets, shovels and traverses for lifting, moving and securing loads. The forged safety latches prevent unintentional detachment from the load. The manufacturing and testing requirements are based on the DGV testing principle GS-OA 15-03.

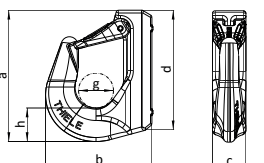

Trade Size	Article-No.	Working Load Limit [t]	Dimensions [mm]						Weight app. [kgs]
			a	c	g	b	h	d	
1	F32751	1,12	94	24	26	77	24	85	0,52
2	F32752	2,00	120	30	33	97	28	107,5	0,84

Lifting Points, Weld-on Type

Spare Part Sets for Weld-on Type Hooks

The spare part sets TWN 1908/0 consist of a safety latch, spring and dowel pin and are suitable for the weld-on hooks TWN 0850/1.

Trade Size	Article-No.	Packing Unit	Weight app. [kgs]
1	F48731	1 set	0,05
2	F48733	1 set	0,08

TWN 1908/0



Weld-on Hooks NEW

The weld-on hooks TWN 0850/2 are primarily welded to earth-moving machines, buckets, shovels and trawlers for lifting, moving and securing loads. The forged safety latches prevent unintentional detachment from the load.

The manufacturing and testing requirements are based on the DGUV testing principle GS-OA 15-03.



Trade Size	Article-No.	Working Load Limit [t]	Dimensions [mm]							Weight app. [kgs]
			e	a	c	g	b	h	d	
1	F32770	1,00	26	108	19	25	72	28	78	0,52
2	F32771	2,00	34	114	20	33	92	28	85	0,70
3	F32772	3,00	34	129	26	33	105	32	104	1,15
5	F32773	5,00	44	167	28	43	138	46	150	2,36
8	F32774	8,00	51	173	42	43	145	53	148	3,32
10	F32775	10,00	67	225	47	60	179	61	197	6,44

TWN 0850/2

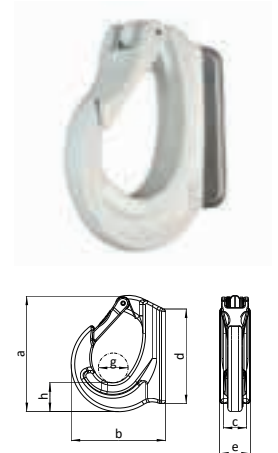

Spare Part Sets for Weld-on Type Hooks

The spare part sets TWN 0913 consist of a safety latch, spring and dowel pin and are suitable for the weld-on hooks TWN 0850/2.

Trade Size	Article-No.	Packing Unit	Weight app. [kgs]
1, 2, 3	Z04496	1 set	0,06
5, 8	Z10614	1 set	0,20
10	Z05842	1 set	0,44

TWN 0913



Weld-on Hooks NEW

The weld-on hooks TWN 1380 are designed for lifting and moving loads and are mainly welded onto earth-moving machines, e.g. shovels. The weld-on hooks consist of a forged hook and a spring-loaded safety latch. They are painted yellow, the areas for the welds are bright.

The design and construction are based on DIN EN 1677-1 as well as the DGUV testing principle GS-OA 15-03.



Trade Size	Article-No.	Working Load Limit [t]	Dimensions [mm]							Weight app. [kgs]
			a	b	c	d	e	g	h	
1	F328701	1,00	125	81	22	70	32	20	70	0,99
2,5	F328702	2,50	163	105	26	90	42	28	90	2,03
5	F328705	5,00	196	129	38	108	52	32	110	4,12
7,5	F328707	7,50	255	161	46	140	75	45	145	8,53
12,5	F328712	12,50	295	178	52	170	80	45	145	12,59

TWN 1380

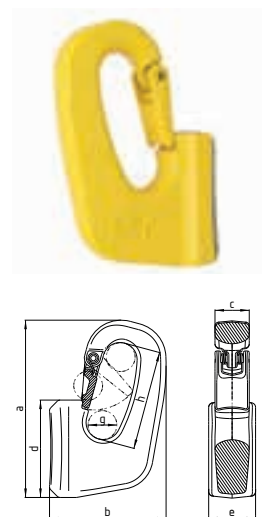



Lifting Points, Weld-on Type

TWN 0949

Spare Part Sets for Weld-on Type Hooks NEW



The spare part sets TWN 0949 consist of a safety latch, spring and dowel pin and are suitable for the weld-on hooks TWN 1380.

Trade Size	Article-No.	Packing Unit	Weight app. [kgs]
1	F48316	1 set	0,05
2	F48317	1 set	0,08
5	F48318	1 set	0,18
7,5/12,5	F48320	1 set	0,31

TWN 1490

Lifting points THI-EYE, weld-on type NEW



The weld-on type lifting points THI-EYE TWN 1490 are used for lifting, moving, and securing of loads, primarily to get welded onto earth-moving machines, shovels, grabs and traverses.

The lifting points may be used with 100% WLL in all directions, are crack tested and feature angle indicators to optimize alignment during the rigging process.

The manufacturing and testing requirements are based on the DGUV testing principal GS-OA 15-03 and the DIN EN 1677-1.

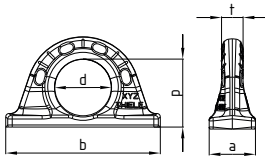

Trade Size	Article-No.	Working Load Limit [t]	Dimensions [mm]					Weight app. [kgs]
			a	b	t	d	p	
3,2	F32300	3,20	41	137	19	50	60	1,00
5	F32301	5,00	51	172	26	60	73	2,20
10	F32302	10,00	70	228	37	80	98	5,20
20	F32303	20,00	90	272	50	115	140	10,5
31,5	F32304	31,50	108	320	62	130	160	18,5

TWN 1872

Lifting Points with two weld-on Brackets



The weld-on lifting points with two weld-on brackets TWN 1872 are used for lifting and moving of loads. The lifting points are predominantly welded on machine frames, steel constructions, traverses and housings. The manufacturing and testing requirements are based on the DIN EN 1677-1, under consideration of higher load capacities.

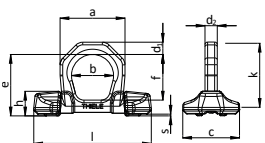

Trade Size	Article-No.	Working Load Limit [t]	Dimensions [mm]											Weight app. [kgs]
			d ₁	d ₂	b	a	l	k	e*	h	c	s	f	
10-10	F352005	4,00	14	14	48	74	137	74	70	28	65	2	52	0,79
13-10	F352015	6,70	20	20	60	100	170	93	85	37	80	2	61	1,73

* Upright standing ring

Lashing Points, Weld-on Type

COMPACT Lifting Points with Spring

The weld-on COMPACT lifting points with fixing spring TWN 1882 are used for lifting and moving of loads. The lifting points are predominantly welded on machine frames, steel constructions, trusses and housings. The compact design allows a small installation space. The manufacturing and testing requirements are based on the DIN EN 1677-1, under consideration of higher load capacities.



Trade Size	Article-No.	Working Load Limit [t]	Dimensions [mm]									Weight app. [kgs]
			d ₁	d ₂	b	a	l	e*	h	c	f	
6-10	F352041	1,50	13	14	38	65	35	68	26	50	42	0,41
8-10	F352051	2,50	15	15	45	76	42	73	27	50	46	0,57
10-10	F352061	4,00	17	17	50	85	46	87	31	56	56	0,84
13-10	F352071	6,70	23	23	68	116	63	122	44	78	78	2,19
16-10	F352081	10,00	27	27	69	130	63	126	54	92	72	3,35

* Upright standing ring

TWN 1882

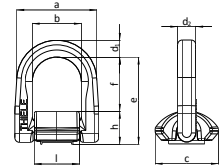

Lashing Points with two weld-on Brackets

The weld-on lashing points with two weld-on brackets TWN 1473 are used for lashing of loads. The lashing points are predominantly welded to the vehicle frame (semi-trailers, trailers). The manufacturing and testing requirements are based on DIN EN 1677-1, under consideration of higher lashing forces.



Trade Size	Article-No.	Article-No. (Ring only)	Lashing Capacity (LC) [daN] max.	Dimensions [mm]										Weight app. [kgs]	
				d ₁	d ₂	b	a	l	e*	k	h	c	s		f
10-10	F352001	F352002	8.000	14	14	48	74	134	74	74	28	65	2	57	0,79
13-10	F352011	F352012	13.500	20	20	60	100	170	85	93	37	80	2	61	1,73

* Upright standing ring

TWN 1473

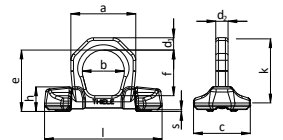

COMPACT Lashing Points with Spring

The weld-on COMPACT lashing points with fixing springs TWN 1880 are used for securing of loads. The lashing points are predominantly welded in recessed skip fittings and on vehicle frames (semi-trailers, trailers). The compact design allows a small installation space. The manufacturing and testing requirements are based on the DIN EN 1677-1, under consideration of higher lashing forces.



Trade Size	Article-No.	Lashing Capacity (LC) [daN]	Dimensions [mm]									Weight app. [kgs]
			d ₁	d ₂	b	a	l	e*	h	c	f	
6-10	F35204	3.000	13	14	38	65	35	68	26	50	42	0,41
8-10	F35205	5.000	15	15	45	76	42	73	27	50	46	0,57
10-10	F35206	8.000	17	17	50	85	46	87	31	55	56	0,84
13-10	F35207	13.500	23	23	68	116	63	122	44	77	78	2,19
16-10	F35208	20.000	27	27	69	130	63	126	54	92	72	3,35

* Upright standing ring

TWN 1880

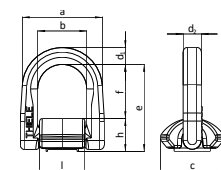



Lashing Points, Weld-on Type

TWN 1477

ZKS-Modules NEW

The weld-on ZKS-modules TWN 1477 are predominantly installed side frames of low-loaders and trailers. The large swivel range also allows the securing of overhanging loads. The pivotable large lashing eyelet built into the cassette enables a fixed mounting position for easy connection with the lashing equipment. The manufacturing and testing requirements are based on the DIN EN 1677-1.

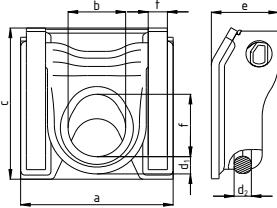

Trade Size	Article-No.	Lashing Capacity (LC) [daN]	Dimensions [mm]								Weight app. [kgs]
			d ₁	d ₂	b	a	t	e	c	f	
10	F352376	10.000	18	18	60	159	20	70	157,5	65	4,95

TWN 1471

ZK-Modules with Stressless Lashing® NEW

The weld-on ZK-modules TWN 1471 are predominantly installed in C-shaped side frames of low-loaders and trailers. The large swivel range also allows the securing of overhanging loads. A newly developed, patented cassette design enables a fixed mounting position for easy connection to the lashing equipment.

Stressless Lashing® in perfection.

The manufacturing and testing requirements are based on DIN EN 1677-1.

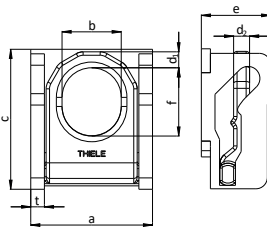

Trade Size	Article-No.	Execution*	Lashing Capacity (LC) [daN] max.	Dimensions [mm]								Weight app. [kgs]
				d ₁	d ₂	b	a	t	e	c	f	
5	F352390	N	5.000	14	14	52	107	12	61	119	60	1,92
5	F352395	S	5.000	14	14	52	107	12	61	119	60	1,95
10	F352380	N	10.000	18	18	62	137	15	73	144	78	3,45
10	F352385	S	10.000	18	18	62	137	15	73	144	78	3,46

*The sheets of the lashing cassette in the execution „N“ (=Normal) are produced in micro-alloyed steel.

The execution „S“ (=Special) are produced from special steel and are therefore capable to get be hot dip galvanized (up to 500°C) with the vehicle frame.



ZK-module on YouTube

General information

The standard DIN EN 12640 specifies the minimum testing requirements for lashing points on road trucks and trailers with flatbed bodies and a permissible total weight of more than 3,5 t for mixed cargo transportation. Lashing points are devices to attach lashing gear.

A lashing point can be an oval link, hook, lug or lashing rail. These types of lashing points may lead to safety issues when in operation.

A non-appropriate dimensioning and use of non-suitable lashing points, as well as the damage of the lashing points and frames of the vehicle, shows a high potential danger in traffic. In operation, oval links are often exposed to unforeseen torque which may cause a damage to the body-work of the vehicles. Very often required inclination angles are not properly considered. Further, oval links can cause unnecessary noise exposure in traffic. The developed THIELE ZK-Modules (lashing ring with cassette) may be easily fitted and adopted at the side frames of trailers.

The ZK-Modules are marked with permissible lashing capacity (LC), manufacturer name (THIELE) and standard number (DIN EN 12640). Official agencies may easily check the correct installation. The ZK-Modules made by THIELE provides highest safety for load securing in the heavy-duty road traffic.

Lashing Points, Weld-on Type

TWN 1471
ZK-Modules with Stressless Lashing® NEW



ZK-module
on YouTube

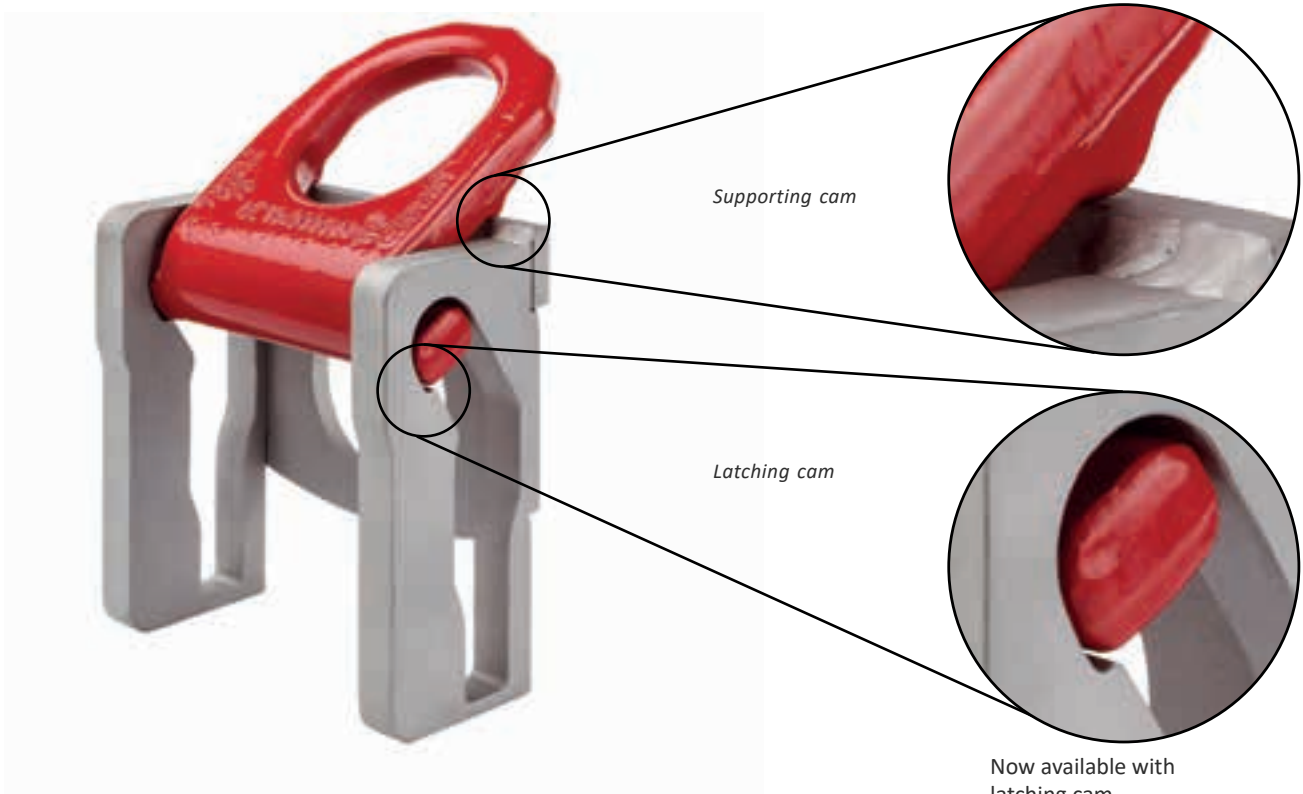

Now available with
latching cam.

Positions:



Rest Position



Hold Position



Position for oversized load



TWN 0301 - 0304 Towing Eyes acc. to DIN 74054



The weld-on towing eyes with shaft TWN 0301 - 0304 serve as coupling elements primarily for drawbars and central axle trailers for the connection with the pins or trailer hitches. The bore dimensions comply with the DIN 74054 parts 1 and 2.

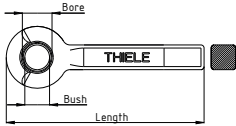

TWN	Article-No.	Type	Length [mm]	Bush [mm]	Bore [mm]	Weight app. [kgs]
0301	F27100	C	320	–	40	3,70
	F27101	A	320	40	48	3,70
0302	F27110	C	350	–	40	4,00
	F27111	A	350	40	48	4,00
0304	F27130	C	360	–	40	5,10
	F27131	A	360	40	48	5,10

TWN 0308 Towing Eyes acc. to DIN 74054



The weld-on towing eyes with shaft TWN 0308 serve as coupling elements primarily for drawbars and central axle trailers for the connection with the pins or trailer hitches. The bore dimensions comply with the DIN 74054 parts 1 and 2.

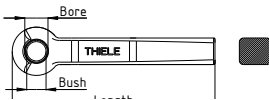

Article-No.	Type	Length [mm]	Bush [mm]	Bore [mm]	Weight app. [kgs]
F27180	C	420	–	40	8,50
F27181	A	420	40	48	8,50
F27182	D	420	-	48	8,50

TWN 0321 Towing Eyes acc. to DIN 74054



The weld-on towing eyes with shaft TWN 0321 serve as coupling elements primarily for drawbars and central axle trailers for the connection with the pins or trailer hitches. The bore dimensions comply with the DIN 74054 parts 1 and 2.

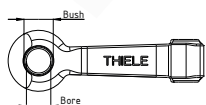

Article-No.	Type	Bush [mm]	Bore [mm]	Weight app. [kgs]
F27300	C	–	40	7,30
F27301	A	40	48	7,30

TWN 0323 Towing Eyes acc. to DIN 74054



The weld-on towing eyes with shaft TWN 0323 serve as coupling elements primarily for drawbars and central axle trailers for the connection with the pins or trailer hitches. The bore dimensions comply with the DIN 74054 parts 1 and 2.

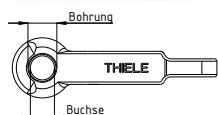

Article-No.	Type	Bush [mm]	Bore [mm]	Weight app. [kgs]
F27320	C	–	40	6,40
F27321	A	40	48	6,40

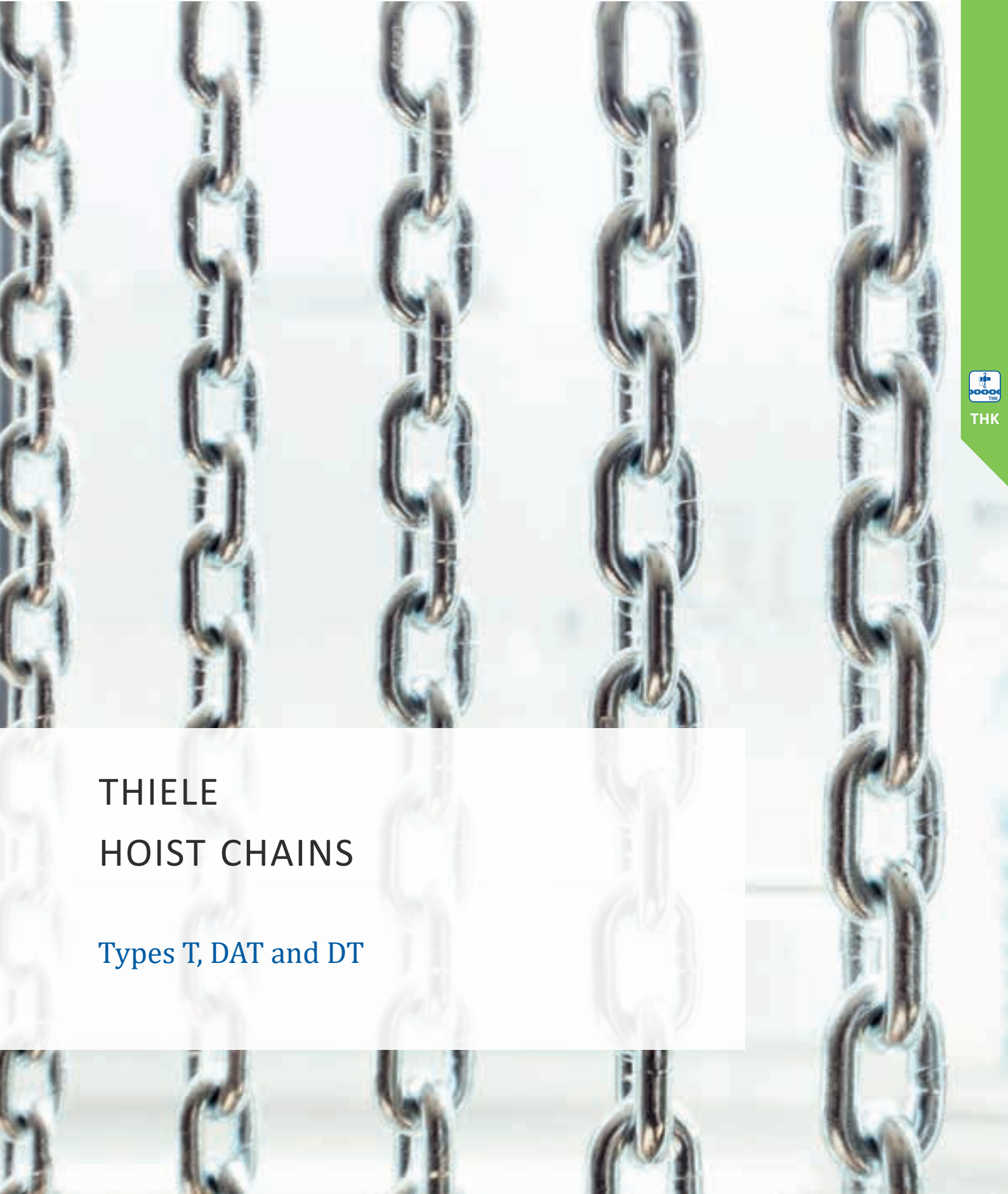

THK

THIELE HOIST CHAINS

Types T, DAT and DT



Hoist Chains



THIELE hoist chains according to the DIN EN 818-7 are manufactured on modern digital controlled production lines. The high dimension accuracy enables high performance hoists a faultless run of the chain over the sprocket. The heat treatment is being done in modern and continuous heat treatment facilities. Therefore, THIELE hoist chains have a homogenous high tensile strength with an outstanding core ductility along the chain strands and roundings.

Hoist chains are designed for the following applications:

T-Type:

- > for manual chain hoists and lever blocks
- > for motor-driven, low-speed hoists

DAT-Type:

- > motor-driven, high-speed hoists with a high load capacity

DT-Type:

- > motor-driven hoists



Advantages of THIELE Hoist Chains:

- High dimension accuracy
- Homogenous high tensile strength
- Outstanding core ductility
- High resistance against brittle fracture (especially with the galvanized version)
- High wear resistance

Hoist Chains

Hoist Chains Type T

The hoist chains TWN 0062 (T type) are used as load chains predominantly in manually operated hoists, e.g. in TM Chain Blocks and TM Lever Blocks. They are also used in motor-driven electric chain hoists that are used as maintenance hoists in wind turbines as maintenance hoists. The hoist chains are tempered, galvanized and comply with the DIN EN 818-7.

TWN 0062

Dimension [mm]	Article-No.		Nominal Size		Pitch		Width		Working Load Limit [t]	Weight app. [kgs/m]	Measuring Length	
	bright polished	electro galvanized	d _n [mm]	Tol. ± [mm]	p _n [mm]	Tol. ± [mm]	w ₁ [mm] min.	w ₂ [mm] max.			11 x p [mm]	Tol. ± [mm]
4 x 12	—	—	4,0	+0,20 / -0,20	12	+0,15 / -0,10	4,80	13,60	0,50	0,35	132,0	+0,40 / -0,20
4,2 x 12,2 ²⁾	—	—	4,2	+0,10 / -0,20	12	+0,15 / -0,10	4,80	13,70	0,50	0,39	134,2	+0,40 / -0,20
5 x 15	—	F09016	5,0	+0,20 / -0,20	15	+0,20 / -0,10	6,00	17,00	0,80	0,54	165,0	+0,50 / -0,30
5,3 x 15,2 ²⁾	—	—	5,3	+0,10 / -0,20	15	+0,20 / -0,10	5,90	16,90	0,80	0,63	167,2	+0,50 / -0,30
6 x 18	—	F09026	6,0	+0,20 / -0,20	18	+0,25 / -0,10	7,20	20,40	1,10	0,79	198,0	+0,60 / -0,30
7 x 21 ¹⁾	F09030	F09031	7,0	+0,10 / -0,28	21	+0,30 / -0,00	8,40	23,40	1,50	1,08	231,0	+0,70 / -0,00
7 x 22	—	F09036	7,0	+0,30 / -0,30	22	+0,30 / -0,15	8,40	23,80	1,50	1,06	242,0	+0,80 / -0,40
7,4 x 21,2	—	—	7,4	+0,10 / -0,30	21	+0,30 / -0,15	8,40	23,80	1,50	1,23	233,2	+1,70 / -0,70
8 x 24	—	F09046	8,0	+0,30 / -0,30	24	+0,30 / -0,15	10,20	27,20	2,00	1,41	264,0	+0,80 / -0,40
9 x 27 ¹⁾	F09050	F09051	9,0	+0,10 / -0,40	27	+0,25 / -0,10	10,80	30,40	2,50	1,79	297,0	+0,70 / -0,30
10 x 30	—	F09056	10,0	+0,40 / -0,40	30	+0,40 / -0,20	12,00	34,00	3,20	2,16	330,0	+1,00 / -0,50
11 x 31 ¹⁾²⁾	F09060	F09061	11,0	+0,30 / -0,40	31	+0,30 / -0,15	13,20	36,50	3,80	2,75	341,0	+0,90 / -0,30
13 x 36 ¹⁾	F09065	F09066	13,0	+0,10 / -0,50	36	+0,35 / -0,15	15,20	42,90	5,30	3,87	396,0	+1,10 / -0,20
16 x 45 ¹⁾	F09070	F09071	16,0	+0,30 / -0,60	45	+0,45 / -0,25	18,20	52,80	8,00	5,82	495,0	+1,40 / -0,50
18 x 50	F09075	F09076	18,0	+0,90 / -0,90	50	+0,65 / -0,35	21,60	61,20	10,00	7,40	550,0	+1,75 / -0,85
22 x 66 ¹⁾	F09080	F09081	22,0	+0,80 / -1,10	66	+0,65 / -0,35	27,00	75,00	15,00	10,70	726,0	+2,00 / -0,70
31,5 x 90 ¹⁾²⁾	F09085	F09086	31,5	+1,60 / -1,60	90	+1,20 / -0,60	37,80	107,10	31,50	22,40	990,0	+3,20 / -1,60

¹⁾ Limited tolerances. Also complies with RAG 726 300. | ²⁾ Similar to DIN EN 818-7

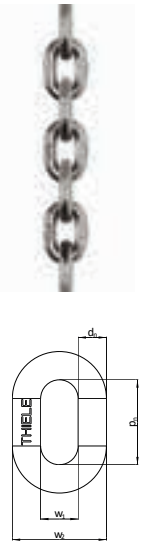

Hoist Chains Type DAT

The hoist chains TWN 0063 (DAT Type) are used as load chains predominantly in electric chain hoists for universal industrial applications. The hoist chains are case-hardened, galvanized and comply with the DIN EN 818-7.

TWN 0063

Dimension [mm]	Article-No.		Nominal Size		Pitch		Width		Working Load Limit [t]	Weight app. [kgs/m]	Measuring Length	
	bright polished	electro galvanized	d _n [mm]	Tol. ± [mm]	p _n [mm]	Tol. ± [mm]	w ₁ [mm] min.	w ₂ [mm] max.			11 x p [mm]	Tol. ± [mm]
4 x 12	—	F09008	4,0	+0,20 / -0,20	12	+0,15 / -0,10	4,80	13,60	0,40	0,35	132,0	+0,40 / -0,20
4,2 x 12,2 ²⁾	—	—	4,2	+0,10 / -0,20	12	+0,15 / -0,10	4,80	13,70	0,40	0,39	134,2	+0,40 / -0,20
5 x 15	—	F09018	5,0	+0,20 / -0,20	15	+0,20 / -0,10	6,00	17,00	0,60	0,54	165,0	+0,50 / -0,30
5,3 x 15,2 ²⁾	—	—	5,3	+0,10 / -0,20	15	+0,20 / -0,10	5,90	16,90	0,60	0,63	167,2	+0,50 / -0,30
6 x 18	—	F09028	6,0	+0,20 / -0,20	18	+0,25 / -0,10	7,20	20,40	0,90	0,79	198,0	+0,60 / -0,30
7 x 21 ¹⁾	—	F09033	7,0	+0,10 / -0,28	21	+0,30 / -0,00	8,40	23,40	1,20	1,08	231,0	+0,70 / -0,00
7 x 22	—	F09038	7,0	+0,30 / -0,30	22	+0,30 / -0,15	8,40	23,80	1,20	1,06	242,0	+0,80 / -0,40
7,4 x 21,2 ²⁾	—	—	7,4	+0,10 / -0,30	21	+0,30 / -0,15	8,40	23,80	1,20	1,23	233,2	+1,70 / -0,70
8 x 24	—	F09048	8,0	+0,30 / -0,30	24	+0,30 / -0,15	10,20	27,20	1,60	1,41	264,0	+0,80 / -0,40
9 x 27 ¹⁾	—	F09053	9,0	+0,10 / -0,40	27	+0,25 / -0,10	10,80	30,40	2,00	1,79	297,0	+0,70 / -0,30
10 x 30	—	F09058	10,0	+0,40 / -0,40	30	+0,40 / -0,20	12,00	34,00	2,50	2,16	330,0	+1,00 / -0,50
11 x 31 ¹⁾²⁾	—	F09063	11,0	+0,30 / -0,40	31	+0,30 / -0,15	13,20	36,50	3,00	2,75	341,0	+0,90 / -0,30
13 x 36 ¹⁾	—	—	13,0	+0,10 / -0,50	36	+0,35 / -0,15	15,20	42,90	4,20	3,87	396,0	+1,10 / -0,20
16 x 45 ¹⁾	—	—	16,0	+0,30 / -0,60	45	+0,45 / -0,25	18,20	52,80	6,30	5,82	495,0	+1,40 / -0,50
18 x 50	—	—	18,0	+0,90 / -0,90	50	+0,65 / -0,35	21,60	61,20	8,00	7,40	550,0	+1,75 / -0,85
22 x 66 ¹⁾	—	—	22,0	+0,80 / -1,10	66	+0,65 / -0,35	27,00	75,00	12,50	10,70	726,0	+2,00 / -0,70
31,5 x 90 ¹⁾²⁾	—	—	31,5	+1,60 / -1,60	90	+1,20 / -0,60	37,80	107,10	31,50	22,40	990,0	+3,20 / -1,60

¹⁾ Limited tolerances. Also complies with RAG 726 300. | ²⁾ Similar to DIN EN 818-7

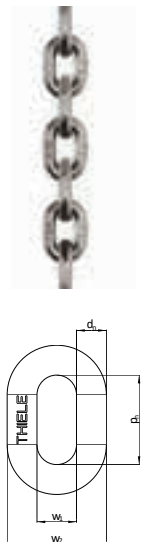

Calibrated Hand Chain

Dimensions	Article-No.	Weight app. [kgs/m]
5 x 25	Z02655*	0,46

*Execution: Electro galvanized



Nominal Stress

Type T	Type DAT	Type DT
[N/mm ²] min.	[N/mm ²] min.	[N/mm ²] min.
200*	160	100

*Only for hand-operated hoists. For motor-driven hoists see DIN EN 818-7.

Mechanical Properties

Nominal Size d _n [mm]	Test Force (MPF) [kN] min.	Breaking Force (BF) [kN] min.
4	12,6	20,1
5	19,6	31,4
6	28,3	45,2
7	38,5	61,2
8	50,3	80,4
9	63,6	102,0
10	78,5	126,0
11	95,0	152,0
12	113,0	181,0
13	133,0	212,0
14	154,0	246,0
16	201,0	322,0
18	254,0	407,0
20	314,0	503,0
22	380,0	608,0

Elongation and Deflection

Type	Properties	Elongation at Break A [%] min.	Deflection f [mm] min.
T		10	0,8 d _n
DAT		10	2,5 x WLL ¹⁾
DT		5	2,5 x WLL ¹⁾

¹⁾ Without surface cracks or visual damages

Surface Hardness

Type	Surface Hardness ¹⁾	d _n < 7 mm [HV5] min.	d _n = 7-11 mm [HV10] min.	d _n > 11 mm [HV10] min.
T		360	360	360
DAT		500	500	450
DT		550	500	500

¹⁾ At defined measuring points acc. to DIN EN 818-7.

Hardening Depth

Type	Hardening Depth at Nominal Size d _n < 8 mm [mm]	Hardening Depth at Nominal Size d _n ≥ 8 mm [mm]
DAT	(0,04 ± 0,01) d _n	(0,03 ± 0,01) d _n
DT	(0,05 ± 0,01) d _n	(0,04 ± 0,01) d _n

Hoist Chains

Chemical Composition

The steel must contain nickel and at least one of the other alloying elements with the minimum contents indicated in the following table:

Type	Mass content according to cast analysis depending on grade		
	Nickel [%] min.	Chromium [%] min.	Molybdenum [%] min.
T	0,40	0,40	0,15
DAT	0,70	0,40	0,15
DT	0,90 ²⁾	0,40	0,15

¹⁾ A higher surface hardness and/or higher hardening depth requires a higher nickel content in order to prevent embrittlement.

Fatigue Strength

THIELE Hoist chains of type T, DT and DAT must be capable of withstanding at least 2×10^6 cycles in the following stress range without failure.

Upper Stress (σ) [N/mm ²] max.	Medium Stress (σ) [N/mm ²]	Lower Stress (σ) [N/mm ²] min.
200	120	40

Operating Temperatures

THIELE hoist chains of type T, DT and DAT can be used at operating temperatures of up to 200 °C. They are not allowed to be used at temperatures above 200 °C.

Type	Lowest Temperature [°C]
T	-40
DAT	-20
DT	-10

Surface

THIELE Hoist Chains are produced as standard in either bright or galvanized finish. Other surface treatments, such as zinc-flake coating and thick-film passivation, are available on request. After the galvanizing, THIELE Hoist Chains are tested with a manufacturers proof force. This is designed to exclude any chains showing signs of material embrittlement.

Marking

The marking complies with the specifications of the DIN EN 818-1.

The quality markings for the hoist chain are 'T', 'DAT' or 'DT', according to type.

Hoist chains must bear the appropriate CE-marking in accordance with the EU-machinery directive, 2006/42/EC if supplied meterwide.

Test Certificates

THIELE Hoist Chains are delivered with the test certificates according to the DIN EN 10254. Declaration of conformity and operating instructions can be downloaded on www.thiele.de. The test certificates must meet the requirements of the DIN EN 818-1.



ISO-Mechanism Groups

Chain Type	Mechanism groups (according to ISO 4301)													
	M ₂		M ₃		M ₄		M ₅		M ₆		M ₇		M ₈	
	T&DAT	DT	T&DAT	DT	T&DAT	DT	T&DAT	DT	T&DAT	DT	T&DAT	DT	T&DAT	DT
Stress	[N/mm ²] min.		[N/mm ²] min.		[N/mm ²] min.		[N/mm ²] min.		[N/mm ²] min.		[N/mm ²] min.		[N/mm ²] min.	
Nominal stress (σ_b) at minimum breaking strength (BF_{min})	800		800		800		800		800		800		800	
Nominal stress at production test force (MPF)	500		500		500		500		500		500		500	
Nominal stress (σ_{lim}) at dynamic limit load (F_{lim})	225	200	200		180		160		140		125		112	
Nominal stress (σ_{cf}) at maximum permissible chain force (F_{cf})	160	100	160	100	140	90	125	80	112	70	100	63	90	56

The stress figures are obtained by dividing the force with the entire cross section of both legs of the link. The stresses are not uniformly distributed; the local tensile stress is much greater, especially at the outer faces of the link.

Recommendation: In order to guarantee an optimised frictionless operation run between the sprocket and hoist chain, we recommend to send your sprocket hoist for on site testing.

Instructions for the correct use of Hoist Chains

- 1. Size Selection**
 Select the size and finish of the chain under consideration of the selection criteria according to the DIN EN 818-7.
- 2. Assembling**
 Pay attention to correct assembly of the chains into the hoist. The hoist chain must be properly guided and should enter and leave the pocket wheel without twisting. In order to ensure that the hoist chain runs smoothly over the pocket wheels without any unusual shocks, the drive wheels and tail wheels must match the type of the chain. The connector element for the hoist in the last link of the chain strand should not widen the profile of the link. There must be a clearance of at least 5 % at the inner width of the hoist chain.
- 3. Cleaning and Lubricating**
 In order to ensure a long service life, hoist chains must be properly lubricated, especially in joint areas. The hoist chain must not be exposed to any kind of contamination that could affect its free mobility.
- 4. Safety Note**
 Hoist chains are not allowed to be used as lifting chains. As well, a hoist chain fitted to a hoist must not be used for bridle hitch or choke hitch slinging.

Discard Criteria

Chain hoists should be immediately withdrawn from service if the chain exhibits any of the following defects:

- Deformation/stretch (also only individual chain links are effected)
- Sign of cut notches, cracks, incipient cracks, pinching, etc.
- Exposure to heat above the permitted temperature range
- Severe corrosion
- Wear in excess of 10 % (on the averaged thickness of chain link)
- Elongation of more than 5 % in the pitch of individual links
- Increase of pitch, dimension of more than 2 % for motor-driven hoists and 3 % for hand-operated hoists (measured over 11 links)
- Illegible markings

Hoist Chains

Maintenance and Handling of Hoist Chains and Drive Wheels

Maintenance:

Hoist chains are subject to significant interlink wear due to the deflection on the drive wheel and, possibly, also on the tail wheels (e.g., lower block).

Further, wear is due to the frictional contact of the chain leg on the wheel pockets or even the guide elements.

To keep this wear to a minimum, a hoist chain should be fully lubricated, if possible, as part of the initial startup.

The lubricating film on the hoist chain left from manufacturing processes or warehousing is not sufficient.

When lubricating, make sure the lubricant also reaches the inner sides of each rounded area on every link. This increases the service life considerably.

If the chain is dirty and unlubricated, this can cause premature wear and subsequent chain failure.

Unless specified different by the chain hoist manufacturer, lubricate the chain, for example, with a mineral oil according to DIN 51502 CLP 220 or, in case of a dusty or dirty environment, with a dry-film lubricant such as UNIMOLY C 220 Spray.

Exceptions:

In rare cases, chain hoists are used in very dusty environments with abrasive media. Because of the lubricant the dust sticks to the chain and thus contributes to wear instead of preventing it. Here, the use of DAT hoist chains (deeper case depth) without lubrication is recommended.

Hoists are also used in food production. This requires the use of stainless steel chains and/ or food grade lubricant depending on the application.

Inspections:

The respective, valid regulations DGUV-54 as well as the stipulations of DIN 685-5, DIN EN 818-7, and DIN EN 818-7 must be observed, as well as the operating instructions of the hoist and any national or local rules and regulations.

The hoist chains should be checked at regular intervals according to the accident prevention rules and regulations. The minimum requirement here is an inspection within one year.

Depending on the operating and environmental conditions (multi-shift, automatic or continuous operation, corrosion, heat, etc.), the hoist chains should be checked at shorter intervals. Inspection intervals are to be defined by the operator in these cases.

The inspection should include checking the dimensional accuracy, deformation, and a visual inspection concerning any possible cracks, notches or similar visual aspects.

The inspection must include the entire chain length in order to be effective. Defects must be repaired immediately, before further operation of the hoist.

After three years, at the latest, an additional inspection for cracks must also be carried out.

The hoist chain must be discarded if the average diameter (d_m) at any point of an individual chain link is less than the nominal thickness (d_n) by more than 10%.

The formula for this is as follows: $d_m = (d_1 + d_2) / 2 < 0,9 \times d_n$ (d_1 and d_2 are to be determined at an offset of 90° to one another in the same cross section)

The hoist chain must also be discarded if the inner pitch of a single chain link has become enlarged by more than 5 % or if any measurement distance across 11 chain links (sum across 11 internal pitches) has increased by more than 2 %.

Hoist manufacturers usually provide exact dimensional values in their operating instructions, or corresponding gauges are available.

The wear of the wheels should be checked if possible during a chain inspection.

If the chain drive is maintained well, used chain wheels can certainly be used with a new hoist chain. However, it is to be assumed that the service life of new hoist chains with used wheels is lower than with new wheels.

Storage:

Store hoist chains must be stored in a dry location at temperatures between 0 °C and 40 °C.



THK



All operating manuals are available in the THIELE download-center on our website www.THIELE.de.



TLA

THIELE LOAD LIFTING EQUIPMENT

TM Chain Blocks, TM Lever Blocks
and TM Girder Clamps



Chain Blocks and Lever Blocks

The THIELE Chain Blocks and Lever Blocks¹⁾ are equipped with an Overload Protection.

Advantages of the Overload Protection:

- Protects the operator from injury
- Protects the hoists from damages
- Extends the service life compared to no overload protection devices
- Complies with the DIN EN 13157, DGUV 54 und GPSG



Label

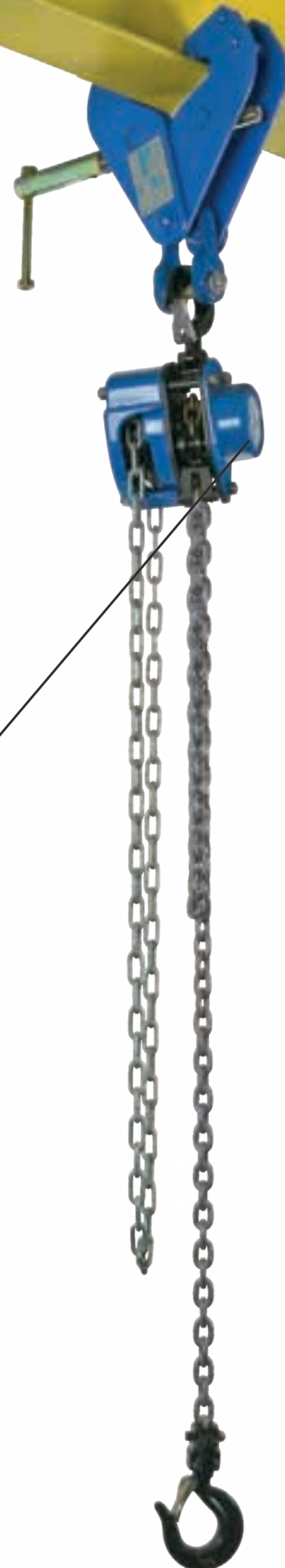

¹⁾ Except TM-LB 025 Lever Block

Chain Blocks and Lever Blocks

Properties:

- With overload protection *
- Light weight robust steel construction
- THIELE alloy load chain according to the DIN EN 818-7-T
- Minimized headroom
- Minimum effort to raise maximum load
- Hooks with strong casted safety latches
- Approved for tensioning according to the DIN EN 12195-3 (TM Lever Blocks only)
- Fully enclosed gear train (TM Chain Blocks only)
- Protected automatic weston brake with twin pawls
- Galvanized hand chains (TM Chain Blocks only)
- Corrosion protection of galvanized load chain
- Durable baked enamel paint protection
- Standard spare parts available
- TÜV- / GS-certified
- Supplied with THIELE test certificates
- Manuals available in 6 languages

TWN 1000
TM Chain Blocks
 Capacities 500 kg
 to 5 tonnes



TWN 1001
TM Lever Blocks
 Capacities 250 kg
 to 6 tonnes



* TM-LB 025 without overload protection



Chain Blocks and Lever Blocks

TWN 1000

TM Chain Blocks

The TM chain blocks TWN 1000 are handoperated portable devices for pulling, lifting and moving of loads. The integrated slipping clutch works as an overload protection. The galvanized THIELE-load chains TWN 0062 comply with the requirements of the DIN EN 818-7.

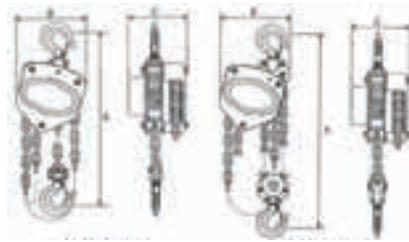

	Unit	TM-B-OP 05N	TM-B-OP 10N	TM-B-OP 20N	TM-B-OP 30N	TM-B-OP 50N
Working Load Limit	[t]	0,5	1,0	2,0	3,0	5,0
Lift app. 3,05 m (10 ft)	[Article-No.]	F063511	F063611	F063711	F063811	F063911
Lift app. 4,60 m (15 ft)	[Article-No.]	F063512	F063612	F063712	F063812	F063912
Lift app. 6,10 m (20 ft)	[Article-No.]	F063513	F063613	F063713	F063813	F063913
Lift app. 9,10 m (30 ft)	[Article-No.]	F063514	F063614	F063714	F063814	F063914
Lift app. 12,20 m (40 ft)	[Article-No.]	F063515	F063615	F063715	F063815	F063915
Chain strands	[pieces]	1	1	1	2	2
Effort to lift for max. Working Load	[kgs] max.	23,00	30,00	35,00	27,00	41,00
Load chain diameter	[mm]	6	6	8	8	10
Headroom (A)	[mm]	270	317	414	465	636
Width (B)	[mm]	127	158	187	210	288
Depth (C)	[mm]	131	140	161	161	190
Hook opening (top)	[mm]	36	42	46	54	64
Hook opening (bottom)	[mm]	36	42	46	54	64
Net weight (for lift 3,00 m)	[kgs]	13,63	16,03	23,76	29,96	28,60
Chain Block only	[Article-No.]	F06353	F06363	F06373	F06383	F06393

TWN 1001

TM Lever Blocks

The TM lever blocks TWN 1001 are hand operated portable devices for pulling, lifting and moving of loads. They can also be used as lashing devices in accordance to the DIN EN 12195-3. The integrated slipping clutch works as an overload protection. The galvanized THIELE-load chains TWN 0062 comply with the requirements of the DIN EN 818-7.

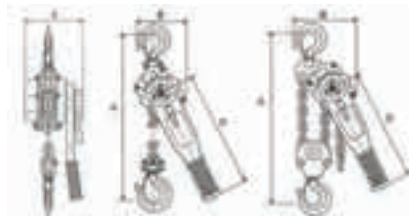

	Unit	TM-LB 025*	TM-LB-OP 075N	TM-LB-OP 150N	TM-LB-OP 300N	TM-LB-OP 600N
Working Load Limit (Lashing Capacity)	[t]	0,25	0,75	1,5	3,0	6,0
Lift app. 1,50 m (5 ft)	[Article-No.]	F061901	F062411	F062511	F062611	F062711
Lift app. 3,05 m (10 ft)	[Article-No.]	F061902	F062412	F062512	F062612	F062712
Lift app. 4,60 m (15 ft)	[Article-No.]	F061903	F062413	F062513	F062613	F062713
Lift app. 6,10 m (20 ft)	[Article-No.]	F061904	F062414	F062514	F062614	F062714
Chain strands	[pieces]	1	1	1	1	2
Effort to lift for max. Working Load	[kgs] max.	2,50	14,00	22,00	32,00	34,00
Load chain diameter	[mm]	4	6	8	10	10
Length of lever handle (D)	[mm]	160	280	410	410	410
Headroom (A)	[mm]	230	325	380	480	620
Width (B)	[mm]	85	136	160	180	235
Depth (C)	[mm]	92	148	172	200	200
Hook opening (top)	[mm]	25	42	46	54	62
Hook opening (bottom)	[mm]	25	42	46	54	62
Net weight (for lift 1,50 m)	[kgs]	2,37	7,10	13,20	21,75	32,97
Lever block only	[Article-No.]	F06192	F06243	F06253	F06263	F06273

*TM-LB 025 without overload protection

Girder Clamps and Displays

TWN 0899

TM Girder Clamps

The TM girder clamps TWN 0899 are predominantly used as attachment points for lifting gears, e.g. TM chain blocks and TM lever blocks, on steel beam profiles. The girder clamps are fastened over a wide flange width range using spindles.

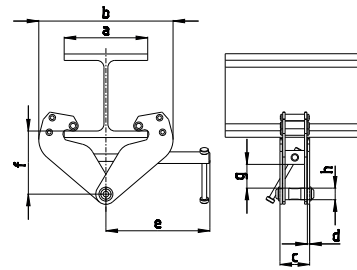

Trade Size	Article-No.	Working Load Limit [t]	Dimensions [mm]										Adjustable beam width [mm]	Weight app. [kgs]
			a	b		c	d	e	f		g	h		
				min.	max.				min.	max.				
1	Z08133	1,00	260	200	360	64	5	215	102	155	25	18,5	75-230	4,40
2	Z08134	2,00	260	200	360	74	6	215	102	155	25	22	75-230	5,10
3	Z08135	3,00	354	235	490	103	8	260	140	225	45	24	80-320	10,10
5	Z08136	5,00	354	235	490	110	10	260	140	225	45	28	80-320	11,80

TM Displays

Modular plug-in unit to display e.g. TM Chain and TM Lever Blocks.

Article-No.	Dimensions [mm]			Weight app. [kgs]
	B	H	T	
F918186	640	1700	490	21,00



Spare Parts for TM Chain Blocks TWN 1000

TWN 1010



Ratchet Discs T.17

The ratchet discs TWN 1010 are used as spare parts for TM chain blocks TWN 1000.

Article-No.	for TM Chain Block Type	Weight app. [kgs]
Z06928	TM-B-OP 05N	0,06
Z06929	TM-B-OP 10N	0,09
Z06930	TM-B-OP 20N	0,15
Z06931	TM-B-OP 30N	0,15
Z06932	TM-B-OP 50N	0,19

TWN 1011



Friction Discs T.16

The friction discs TWN 1011 are used as spare parts for TM chain blocks TWN 1000.

Article-No.	for TM Chain Block Type	Weight app. [kgs]
Z06934	TM-B-OP 05N	0,01
Z06935	TM-B-OP 10N	0,02
Z06936	TM-B-OP 20N	0,03
Z06937	TM-B-OP 30N	0,03
Z06938	TM-B-OP 50N	0,03

TWN 1013



Safety Latch Sets T.7N

The safety latch sets TWN 1013 consist of safety latch, spring, screw and nut and are used in load hooks of the TM chain blocks TWN 1000.

Article-No.	for TM Chain Block Type	Weight app. [kgs]
Z09944	TM-B-OP 05N	0,02
Z09945	TM-B-OP 10N	0,03
Z09946	TM-B-OP 20N	0,04
Z09947	TM-B-OP 30N	0,05
Z09948	TM-B-OP 50N	0,10

TWN 1015



Top Load Hooks T.6N

The load hooks with attachments TWN 1015 are used as top load hooks in TM chain blocks TWN 1000.

Article-No.	for TM Chain Block Type	Working Load Limit [t] max.	Weight app. [kgs]
Z09939	TM-B-OP 05N	0,50	0,34
Z09940	TM-B-OP 10N	1,00	0,52
Z09941	TM-B-OP 20N	2,00	0,81
Z09942	TM-B-OP 30N	3,00	1,90
Z09943	TM-B-OP 50N	5,00	11,50

TWN 1017



Bottom Load Hooks T.8N

The load hooks with attachments TWN 1017 are used as bottom load hooks in TM chain blocks TWN 1000.

Article-No.	for TM Chain Block Type	Working Load Limit [t] max.	Weight app. [kgs]
Z09949	TM-B-OP 05N	0,50	0,35
Z09950	TM-B-OP 10N	1,00	0,58
Z09951	TM-B-OP 20N	2,00	0,85
Z09952	TM-B-OP 30N	3,00	2,03
Z09953	TM-B-OP 50N	5,00	13,90

Spare Parts for TM Lever Blocks TWN 1001

Friction Disk and Ratchet Disc Sets T.21N

The friction and ratchet discs TWN 1012 are used as spare clutches for the integrated overload protection of the TM lever blocks TWN 1001.

Article-No.	for TM Lever Block Type	Weight app. [kgs]
Z09455	TM-LB-OP 075N	0,13
Z09454	TM-LB-OP 150N	0,20
Z09456	TM-LB-OP 300N/600N	0,25

TWN 1012



Safety Latch Sets T.9N

The safety latch sets TWN 1014 consist of safety latch, spring, screw and nut and are used in load hooks of the TM lever blocks TWN 1001.

Article-No.	for TM Lever Block Type	Weight app. [kgs]
Z09976	TM-LB-OP 075N	0,03
Z09977	TM-LB-OP 150N	0,04
Z09978	TM-LB-OP 300N	0,05
Z09979	TM-LB-OP 600N	0,06

TWN 1014



Top Load Hooks T.8N

The load hooks with attachments TWN 1016 are used as top load hooks in TM lever blocks TWN 1001.

Article-No.	for TM Lever Block Type	Working Load Limit [t] max.	Weight app. [kgs]
Z09968	TM-LB-OP 075N	0,75	0,49
Z09969	TM-LB-OP 150N	1,50	0,88
Z09970	TM-LB-OP 300N	3,00	2,20
Z09971	TM-LB-OP 600N	6,00	4,50

TWN 1016



Bottom Load Hooks T.10N

The load hooks with attachments TWN 1018 are used as bottom load hooks in TM lever blocks TWN 1001.

Article-No.	for TM Lever Block Type	Working Load Limit [t] max.	Weight app. [kgs]
Z09972	TM-LB-OP 075N	0,75	0,50
Z09973	TM-LB-OP 150N	1,50	0,95
Z09974	TM-LB-OP 300N	3,00	2,50
Z09975	TM-LB-OP 600N	6,00	6,70

TWN 1018



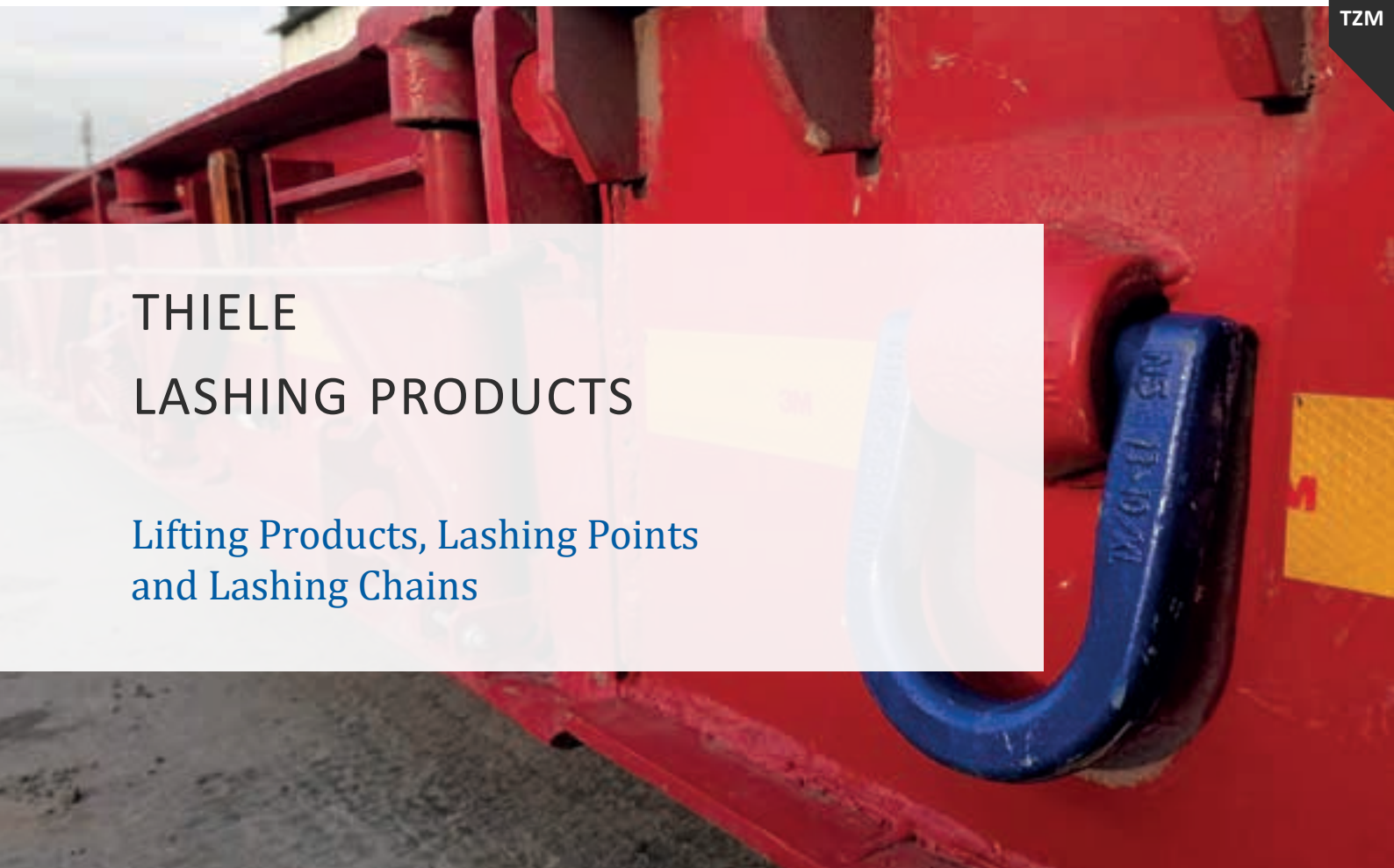
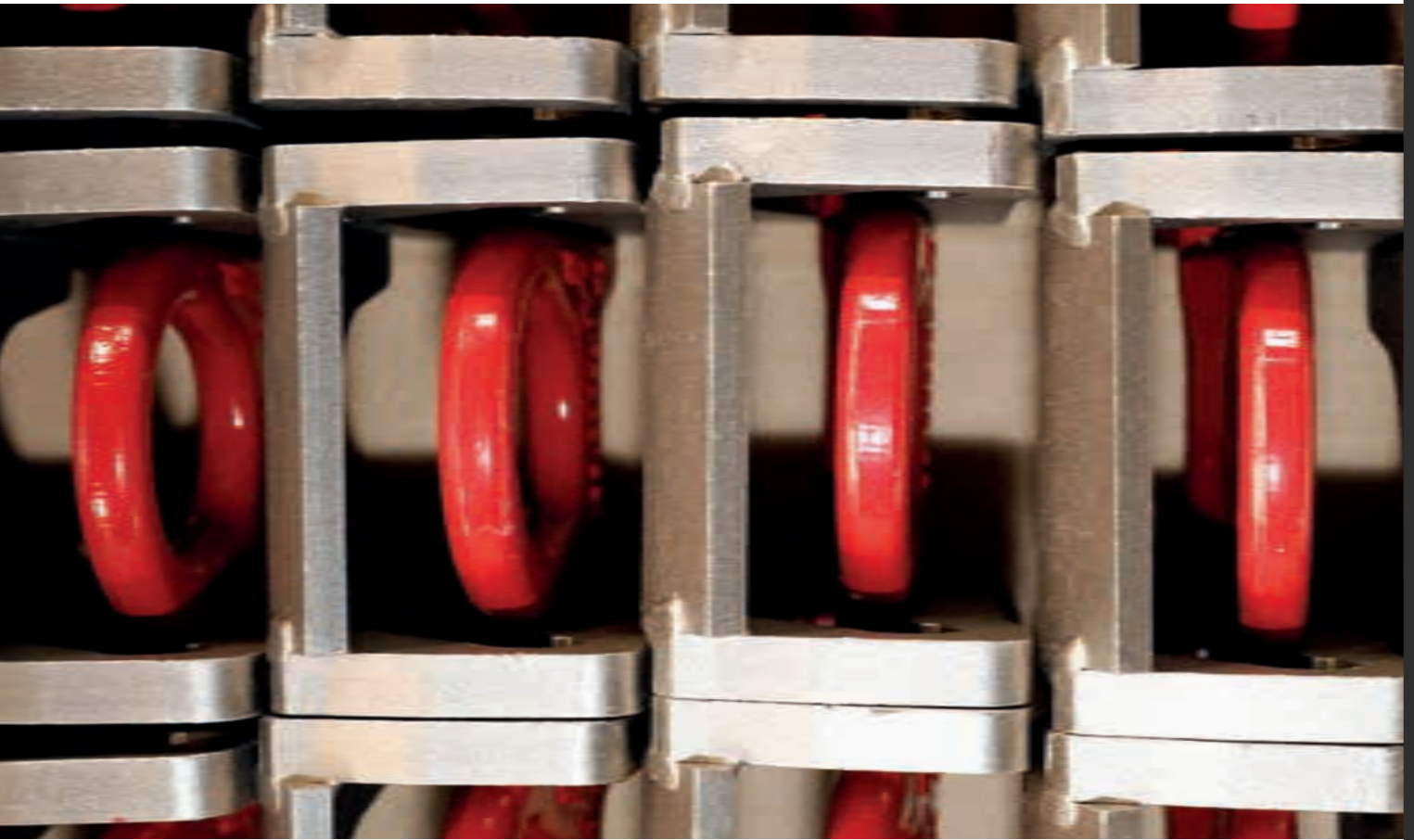
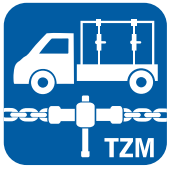

THIELE LASHING PRODUCTS

Lifting Products, Lashing Points
and Lashing Chains



Product Overview of Lashing Products

Pages
150-156

Grade 100 Lashing Chains and Components

TWN 1410 / TWN 1411		TWN 0072		TWN 1805
TWN 1454	TWN 1455	TWN 1460	TWN 1473	TWN 1474
TWN 1880	TWN 1890	TWN 1820	TWN 1851/1	TWN 1852
TWN 1827/1	TWN 1869	TWN 1840/1	TWN 1899	

Pages
157-162

Grade 80 Lashing Chains and Components

TWN 1400 / TWN 1401			TWN 0805	
TWN 1479	TWN 1450	TWN 1451	TWN 1452	TWN 0119
TWN 0124	TWN 1477	TWN 1471	TWN 1320	TWN 0851/1
TWN 0827/1	TWN 0869	TWN 1340/1	TWN 1399	

Page
163

Tensioning Components

TWN 1001				

General Information

Load securing protects the load against the physical forces of movement that occur during transport.

Vehicles that are carrying insufficiently secured loads are encountered in traffic every day. Changes in speed or direction produce forces causing the cargo to no longer stay in position and to move on the vehicle.

To avoid this risk, every load has to be secured properly on the carrier regardless of whether it is light or heavy and even when the vehicle runs at low speed. The conditions for load securing are derived from "normal" driving operations. At "normal" driving operation, however, is not only to be understood as a foresighted and quiet driving. Normal traffic conditions also include, e.g. emergency braking, uneven road surfaces, extreme evasive maneuvers, etc.

When securing loads, all these influences must be taken into consideration. If securing proves ineffective, insurance coverage may be lost partly or even entirely. In such a case, the responsible person and company must bear the costs which may then often lead to economic ruin.

Many dedicated persons are not aware that the responsibility for load securing does not only lie on driver of a vehicle but also with all other parties involved (e.g. vehicle owner, sender, carrier, hauler, etc.).

Physical Basics

In the event of an emergency braking operation of the vehicle down to zero speed, deceleration rates of up to 8 m/s^2 may arise which means that 80 % of the weight of a given cargo component has to be absorbed by load securing to prevent the load from shifting.

The centrifugal forces acting transversely to the direction of travel must be taken into consideration. The design of commercial vehicles permits building acceleration rates up to 5 m/s^2 . This means that 50 % of the cargo weight has to be secured transversely to the direction of travel.

Arising Forces in Driving Operation

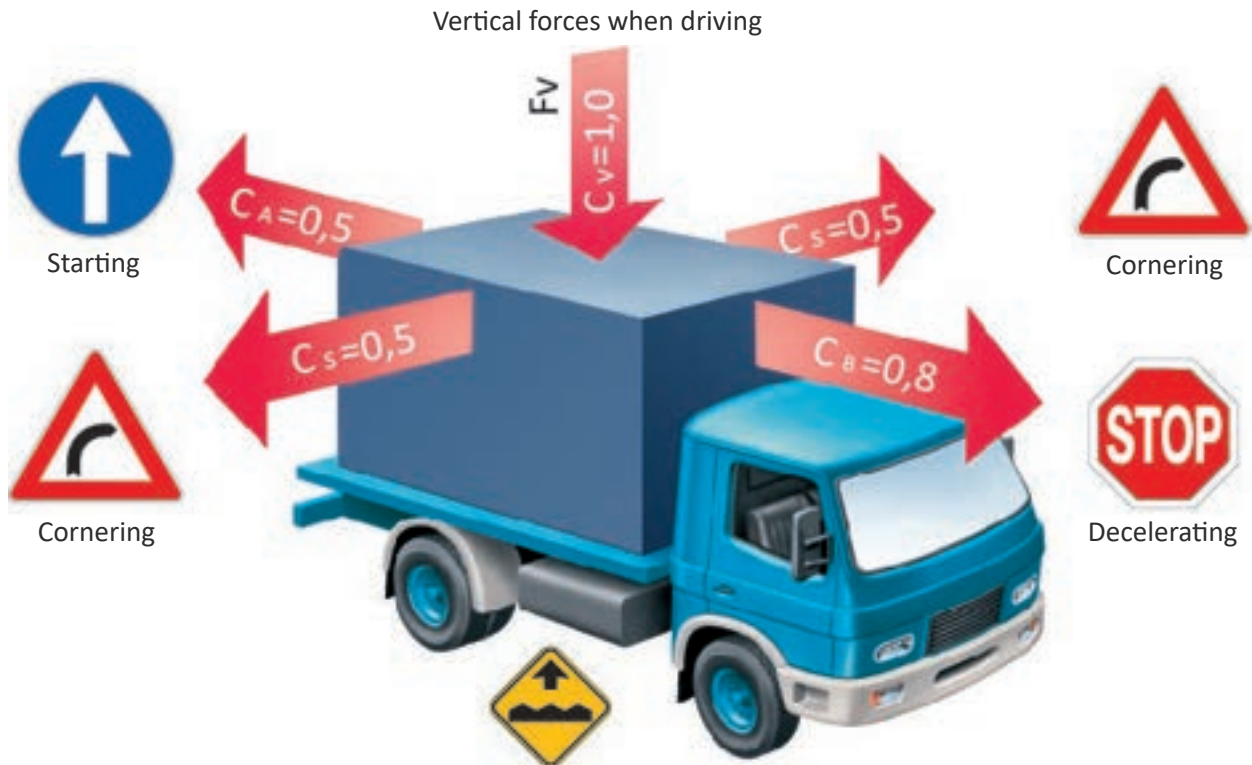

Starting

Weight forces (acceleration forces) to the rear
 $F_A = 0.5 \times F_V = 50\%$ of the cargo weight

Decelerating

Weight forces (deceleration forces / negative accelerations) to the front
 $F_B = 0.8 \times F_V = 80\%$ of the cargo weight

Cornering

Weight forces (centrifugal forces) acting sideways
 $F_S = 0.5 \times F_V = 50\%$ of the cargo weight

Forces of Cargo

Assuming a cargo weight of $m = 15.000$ kgs then the vertical force of cargo F_V is 15,000 daN.
 All these forces must be retained by means of load securing and lashing devices.

Cargo Weight	Forces of Cargo	Force
[%]		[daN] min.
100	Vertical force of cargo	$F_V = 15.000$
80	Longitudinal forward force	$F_B = 12.000$
50	Transverse force of cargo (right/left)	$F_S = 7.500$
50	Longitudinal rearward force	$F_A = 7.500$

General Information

Methods of Load Securing

In general a distinction between force- and form-closed cargo securing is to be made:



Tie-down Lashing

The most common type of load securing is the tie-down lashing (pictures 1 and 2 on pages 142 and 143). The load securing devices are put over the cargo, attached to lashing points and tightened by using maximum hand force.

The pre-tensioning force presses the cargo onto the load area and thereby applies frictional forces. The sum of the weight itself and the pressing forces take effect in all directions. This is the major advantage of the tie-down lashing method.

The vertical angle α primarily determines the effectiveness of the tie-down lashing method. When using a 90° angle, 100 % of the force is introduced into the lashing system. At 30° it is only 50 %. Therefore the lashing angle β should not exceed 30°.

Following points should be considered for tie-down lashing operations:

- A high degree of friction must exist between the cargo and the loading surface as well as amongst the individual loading units.
- The sliding friction coefficient must be known or estimated.
- The cargo must be able to withstand the pre-tensioning force.
- The lashing points on the vehicle must be designed to take the arising loads.
- Due to the so called settling processes, the pre-tension of the load securing devices must be regularly checked during transit in order to rule out that pre-tensioning forces will decrease and no longer be adequate.

The magnitude of the frictional force depends on the characteristics of the materials that come into contact with each other. It is clearly evident that a piece of metal will easier slide on a metal surface than on a surface consisting of rubber.

In practical tests on load surfaces as well as in laboratory tests a multitude of so called sliding friction coefficients have been determined which serve as calculation basis for cargo securing purposes.

These coefficients are identified by the symbol μ_D .

Dynamic friction coefficients of common cargo

Material pairing	Sliding friction coefficient (μ_D)
Steel on steel, oiled	0,10
Timber on steel plates	0,30
Steel on wood	0,40
Pre-cast concrete components with wood interlayer on wood (concrete/wood/wood)	0,40
Concrete on lattice beams	0,60

Force introduction via the tensioning element

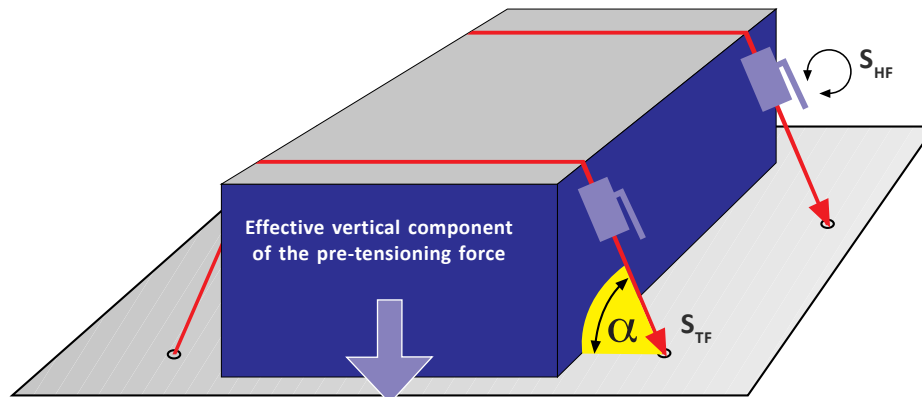

Picture 1

When lashing down, different pre-tensioning forces are required depending on the lashing angle.

- S_{HF} = Standard Hand Force (max. 50 daN) applied to the lever of the ratchet or screw tensioner. Only if the tensioning element is tightened by hand (S_{HF}) at 50 daN, the pretensioning force (S_{TF}) indicated on the identification tag may be reached.
- S_{TF} = Standard Tension Force is the remaining force after the lever of the tensioning device has been released; i.e. the real remaining force exerted by the load securing device.

The pre-tensioning force F_T is determined according to the following formula:

$$F_T \geq \frac{C_{A,S} - \mu_D}{\mu_D \times \sin \alpha} \times \frac{F_V}{k \times n} \quad [\text{daN}]$$

The meaning of formula symbols:

- $C_{A,S}^*$ = Acceleration coefficient (in travel direction $C_A = 0.8$; transversely and counter to the drive direction $C_S = 0,5$)
- C_V^* = Acceleration coefficient, vertical
- μ_D = Dynamic friction coefficient (sliding friction coefficient)
- $\sin \alpha$ = Sine function of the lashing angle
- F_V = Vertical force of the cargo (cargo weight); ($F_V = m \times g \times C_V$)
- k = Transfer coefficient (loss of pre-tensioning force due to friction between the cargo and the load securing device)
1,5 times if the load securing device is tightened by means of a tensioning device
- n = Number of lashing devices

*Assumption: Cargo on road trucks and trailers

General Information

Over-the-top lashing

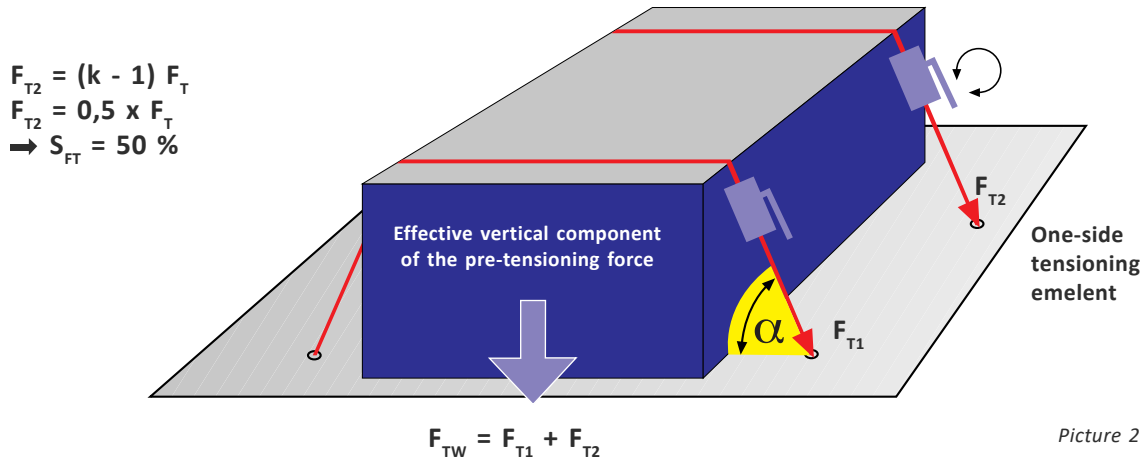

Pretensioning forces

Table 3 provides estimated pre-tensioning forces that are required to safely secured cargos. The data shown is based on material pairings listed in table 2. As shown in table 3, the sliding friction coefficients and lashing angles are decisive!

Cargo-weight (F_v) [daN] max.	Sliding-friction coefficient (μ_D)	Lashing Angle (α)	Total pre-tensioning force (F_T) [daN] max.	Lashing Angle (α)	Total pre-tensioning force (F_T) [daN] max.
2.000	0,10	50°	12.185	80°	9.485
	0,40	50°	1.745	80°	1.355
	0,60	50°	580	80°	455
10.000	0,10	50°	60.925	80°	47.425
	0,40	50°	8.725	80°	6.775
	0,60	50°	2.900	80°	2.275
30.000	0,10	50°	182.775	80°	142.275
	0,40	50°	26.175	80°	20.325
	0,60	50°	8.700	80°	6.825

Table 3

Pretensioning forces

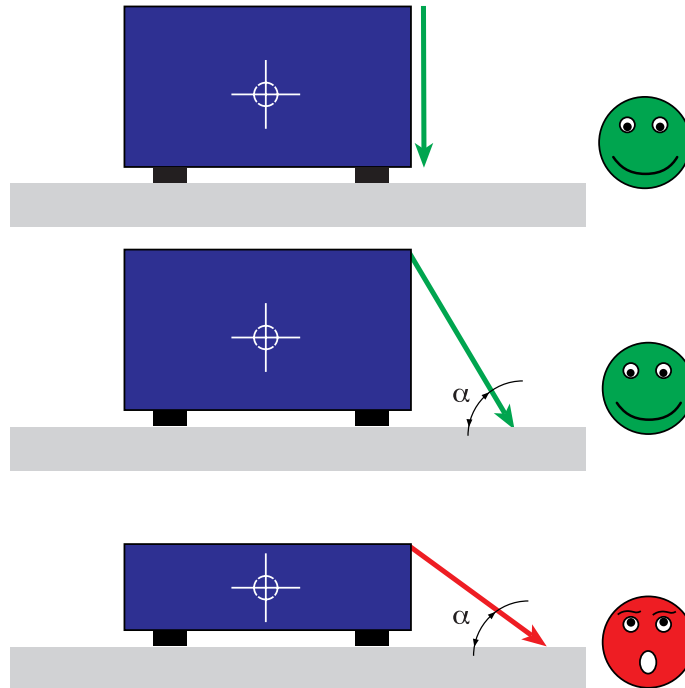

Significantly high pre-tensioning forces are sometimes needed and it is obvious that such forces may only be applied with appropriately sized load securing devices.

The most important parameters of load securing devices are as follows:

➔ **Lashing Capacity (LC)**

➔ **Standard Tension Force (S_{TF})**

$S_{TF, min.} = 0,25 \times LC$ for chains with diameter from 6 to 10 mm

min. = $0,15 \times LC$ for chains with diameter from 13 and 16 mm

$S_{TF, max.} = 0,50 \times LC$

Both characteristics may be found on the identification tags of the lashing chains. The lashing force is the largest force in straight pull, for which a lashing device is designed to use. The Standard Tension Force (S_{TF}) is the force that remains in the load securing device when the tensioning lever has been released, i.e. the actual remaining force exerted by the system.

To determine how many lashing elements are needed, the calculated total pre-tensioning force must be divided by the standard tension force of the selected load securing devices. When using belt systems, a double-digit number of belts may be necessary for common loads which is unsuitable for practical purposes.

However, by using THIELE-lashing chains, you may reduce the required number of tensioning devices by a factor eight. It is generally recommended to use anti-slip mats for tie-down lashing and direct lashing to increase the coefficient of friction.

General Information

Direct Lashing

Direct lashing is a highly effective cargo securing method, as it makes use of the lashing capacity of the lashing device. Since the load securing device is not pretensioned, only little manual force is needed for tightening. The lashing device must be fixed to a lashing point at the load area and then at the cargo itself. It shall only be pretensioned by hand power in order to avoid sagging or swinging of the chain.

The measure for the design of a chain to be used as a securing device is calculated as the lashing capacity (LC). The lashing capacity is the decisive parameter for the chain size as well as for the related tensioning and connecting elements.

Diagonal Lashing

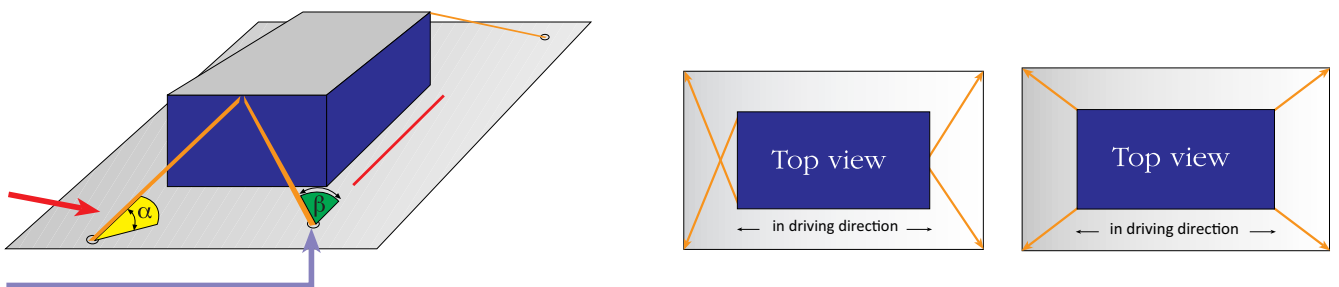

For diagonal lashing, physical laws prescribe the limits according to which the lashing angles should be selected. Calculations show that it is recommended to keep horizontal angles in line between 20° and 45°. If the angle is smaller than 20° and the friction coefficient is smaller than 0.5, an additional dimensioning of the average lashing force against slipping during vehicle cornering is required. If the angle is larger than 60°, then the lashing capacity will increase disproportionately. Theoretically, they would even be infinitely larger with a 90° angle. Based on these considerations, it can be stated that a diagonal/cross-wise lashing method is not favorable for securing of loads in driving direction, at least in an extreme configuration (horizontal angle). There are also recommendable limits at the vertical angles to avoid disproportional increase of the forces in the tensioning device. The best use of the average lashing capacities is at a vertical angle between 0° and 20°.

The requested lashing capacity (LC) is calculated according to the following formula, considering the described factors:

$$LC \geq \frac{F_V \text{ [daN]} \times (C_{A,S} - \mu_D)}{(\sin \alpha \times \mu_D + \cos \alpha \times \cos \beta) \times n}$$

Based on the equation a lashing device that has at least the same admissible lashing capacity must be selected.

Symbols used in the equation:

- LC = Lashing Capacity
- F_V = Vertical force of the cargo (cargo weight); ($F_V = m \times g \times C_V$)
- μ_D = Dynamic friction coefficient (sliding friction coefficient)
- $C_{A,S}^*$ = Acceleration coefficient (in driving direction $C_A = 0,8$;
transversely and counter to driving direction $C_S = 0,5$)
- C_V^* = Acceleration coefficient, vertical
- α = Vertical angle of the lashing
- β = Horizontal angle of the lashing chain strands
- n = Number of lashing chains in the respective direction

*Assumption: Cargo on road trucks and trailers



General Information

Lashing chains are the best way to secure loads. They offer major advantages as their working capacity is known. This allows an exact calculation to secure the loads.

For standard lashing chains exclusively short link round steel chains acc. to DIN EN 818-2 or PAS1061/ ASTM973 must be used.

In your own interest as well as public safety, only shortening elements according to DIN EN 1677-1 that are approved by the manufacturer may be used. When using self-made shorteners, the capacity of the lashing devices can no longer be granted.

When using lashing hooks, all safety requirements of the DIN EN 1677-2 must be observed (hooks with safety latches) and taken into consideration.

Connecting and shortening components must have devices that are preventing the chain from unintentional release.

Screw tensioners must have a safety device (securing of screw removal) against unintentional release.

Multi purpose lever blocks must meet the DIN EN 13157 requirements.

A complete Lashing Chain according to the DIN EN 12195-3 consists of:

Load Securing Devices	Tensioning Elements	Connecting Elements	Identification Tags
Lashing chains	Tighteners, Tensioners, Multi purpose ratchet hoists	Hooks, Shackles, Chain shorteners, End-links	Metal tags



General Information

Inspection of Lashing Chains

Load securing devices are subject to wear and can be damaged by improper use. It is strictly required to inspect round steel chains and components by a qualified person in regular intervals in order to make sure that they are taken out of service or repaired without delay if damaged or worn out.

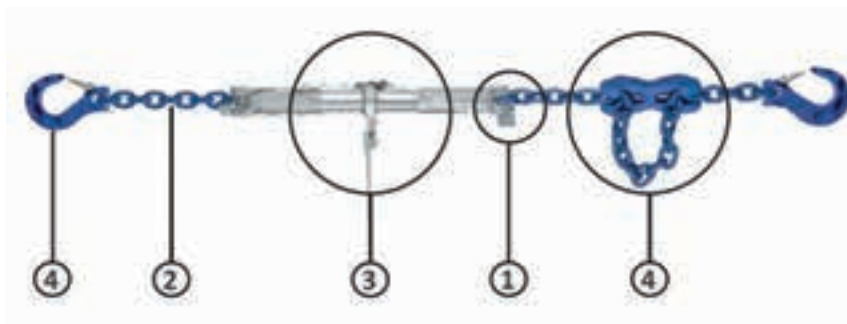

Criteria for rejection from operation:

Component	Indicators
1. Identification Tag - Tag conforming to standard	> Missing or illegible tags
2. Load Securing Device - Lashing Chain	> Elongation of a single link at the outer length of more than 3 % > Elongation of a single link in the pitch of more than 5 % > Wear exceeding 10 % of the nominal diameter > Deformation > Surface cracks
3. Tensioning Element - Tensioner - Tightener - Multi purpose ratchet hoist	> Deformation > Cracks > Severe signs of wear > Severe corrosion
4. Component - End link - Chain connector - Shackle - Shortening claw - Shortening hook - Lashing hook	> Deformation > Cracks > Severe signs of wear > Severe corrosion > Hook widening by more than 10 %



TZM



Inspection of Lashing Chains

Do NOT use...

... round steel chains:

- with working load limit or lashing capacity lower than specified standards DIN EN 818-2/ PAS 1061/ ASTM 973
- without manufacturer identification

... tensioning elements:

- without screw removal mechanism
- without manufacturer identification
- with long extended handles that are capable of producing a pre-tensioning force over 0.5 x LC

... shortening components or lashing hooks:

- that may reduce the breaking force of the chain
- without safety latches or locking pins

Lashing Hooks / Sling Hooks with Safety Latch

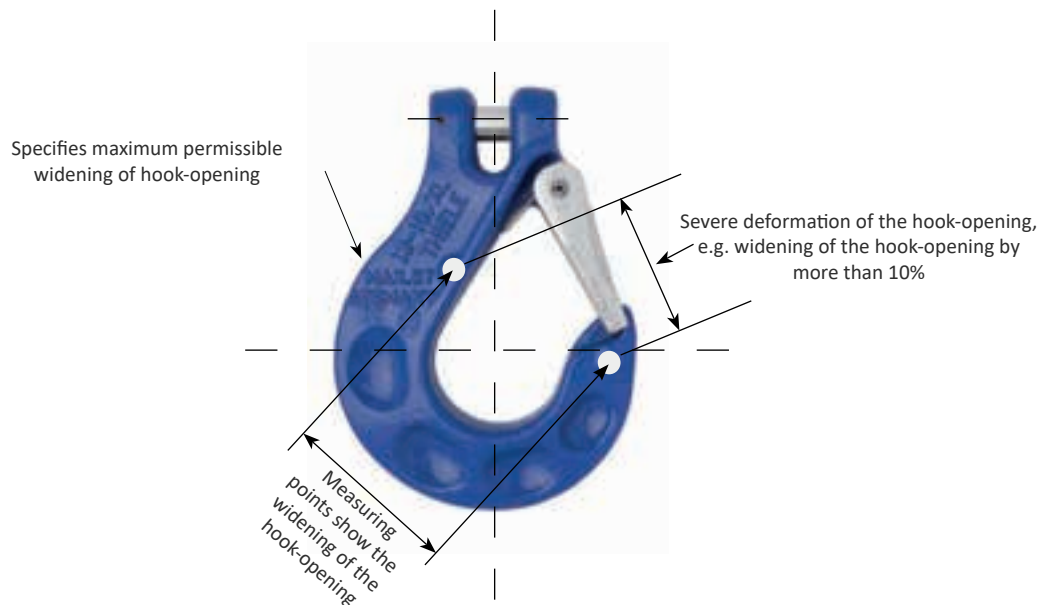

The embossed maximum permissible limit with measuring points enables an easy check of the hook-opening.

Repair work must exclusively be performed by qualified personnel. Only clearly identifiable lashing chains are allowed to be repaired.

THIELE offers regular in-house and on-site competence trainings.

More detailed information about the inspection of lashing chains are provided in the THIELE operating instructions.

All operating manuals are available in the THIELE download-center on our website www.THIELE.de.



General Information

Identification Tags

THIELE lashing chains are equipped with an identification tag that specifies the characteristics of the chain. A clear identification of the chain is given and mix-ups are avoided. The information on the tags according to the DIN EN 12195-3 is required.

Identification Tag according to the DIN EN 12195-3:



Tags as per DIN EN 12195-3 show on their front the number of the standard specification, the name of the chain manufacturer, the inspection number, as well as a warning that the chain must not be used for lifting. On the back side of the tag the maximum permissible lashing capacity (LC) in kN and standard tensioning force (S_{TF}) in daN is hard-stamped.

How to use Lashing Chains

To ensure that lashing chains have a long service life, there are some aspects to be observed during operation:

- Do not overload lashing chains.
- The maximum hand force of 50 daN must only be applied manually.
The use of bars, levers or similar is prohibited.
- Make sure the lashing chain cannot damage the cargo and vice versa.
- Make use of e.g. edge protectors to prevent damage to the cargo and wear to the chain.
- Never use chains with knots or chains connected by screws, bolts or similar.
- To shorten chains, only use the shortening components offered and approved by the chain manufacturer, otherwise the safety of the chain cannot be granted.

TWN 1402

Identification Tags for Lashing Chains

The identification tags TWN 1402 are used to identify lashing chains and provide important information for safe operation. Lashing chains and chain slings may not be operated without identification tags.



Article-No.	Packaging Unit	Weight app. [kgs]
Z07264	1 piece	0,05



Grade 100 Lashing Chains and Components



When using the sling chains as a lashing chain, the maximum lashing force LC (Lashing Capacity) results by doubling the load capacity WLL (Working Load Limit): $LC = 2 \times WLL$.

If the products are initially used for lifting, e.g. internal transport, up to the load capacity, they can still be used as lashing products. If lifting products are used for lashing, they may no longer be used for lifting anymore!

TWN 1410



Lashing Chains with Tensioner

The grade 100 lashing chains with toggle and adjustable lashing chain TWN 1410 have a standard length of 3,5 m and are used for heavy-duty lashing applications. The chain tensioners with toggles and trapezoidal threads achieve a high pre-tensioning force with little force impact. This property is of fundamental importance when lashing down, as the level of the pretensioning force contributes to load securing. The manufacturing and testing requirements are based on the DIN EN 12195-3, under consideration of grade 100 lashing forces.



Trade Size	Article-No.	Lashing Capacity [daN]	Weight app. [kgs]
13-10	F34183	13.000	28,39
16-10	F34184	20.000	46,43

Other lengths available on request.

TWN 1411



Lashing Chains with Ratchet

The grade 100 lashing chains with ratchet and shortenable lashing chain TWN 1411 have a standard length of 3,5 m and are used in the heavy-duty area for lashing loads in road traffic. The chain tensioner with ratchet and trapezoidal thread achieves a high pre-tensioning force with little force impact. This property is of fundamental importance when lashing down, as the level of the pre-tensioning force contributes to load securing. The manufacturing and testing requirements are based on the DIN EN 12195-3, under consideration of grade 100 lashing forces.



Trade Size	Article-No.	Lashing Capacity [daN]	Weight app. [kgs]
13-10	F34183R	13.000	21,00
16-10	F34184R	20.000	48,13

Other lengths available on request.

TWN 0072



Lifting Chains XL200

Grade 100 lifting chains XL200 are made from CrNiMo alloy steel and are used to assemble chain slings or lifting/ lashing chains. The max. application temperature is 205°C. The testing requirements for these high-quality lashing chains are based on the DIN EN 818 and ASTM 973.



Trade Size	Article-No.	Working Load Limit [t]	Nominal Size d_n [mm]	Pitch p_n [mm]	Inside Width w_3 [mm] min.	Outside Width w_2 [mm] max.	Weight app. [kgs/m]
6-10	F01616	1,40	6	18	8,40	22,20	0,90
7-10	F01621	1,95	7	21	9,53	25,90	1,10
8-10	F01617	2,60	8	24	11,30	29,60	1,60
10-10	F01618	4,00	10	30	13,40	37,00	2,44
13-10	F01619	6,80	13	39	18,00	48,10	4,07
16-10	F01620	10,30	16	48	21,40	59,20	6,20

Grade 100 Lashing Chains and Components

Lifting Chains XL400

The grade 100 lifting chains XL400 are made from CrNiMo alloy steel and are used to assemble chain slings or lifting chains. The max. application temperature is 380°C. The lifting chains are especially characterized by their certified fatigue strength and corrosion resistance. The testing requirements for these high-quality lashing chains are based on the DIN EN 818, PAS 1061 and on the German Statutory Accident Insurance test principle GS-HM 37.



Trade Size	Article-No.	Working Load Limit [t]	Nominal Size d_n [mm]	Pitch p_n [mm]	Inside Width w_3 [mm] min.	Outside Width w_2 [mm] max.	Weight app. [kgs/m]
6-10	F01610B	1,40	6	18	8,40	22,20	0,89
8-10	F01615B	2,50	8	24	11,30	29,60	1,59
10-10	F01622B	4,00	10	30	13,40	37,00	2,48
13-10	F01629B	6,70	13	39	18,00	48,10	4,18
16-10	F01635B	10,00	16	48	21,40	59,20	6,34

Lashing chains are identical in construction to sling chains of the same grade and trade size.

TWN 1805

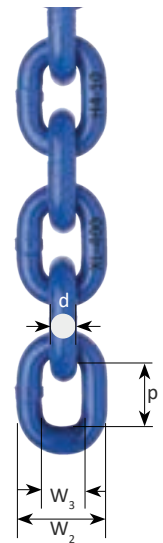

Chain Tensioners with Toggle (Large Lift)

The grade 100 chain tensioners with toggle TWN 1454 are used as tensioning elements in lashing chains. The chain tensioners can also be used in chain slings for stepless adjustment of the strand length when lifting loads. These chain tensioners have a particularly large lift. The chain tensioners with toggles and trapezoidal thread achieve a high pre-tensioning force with little force impact. This property is of fundamental importance when lashing down, as the level of the pretensioning force contributes to load securing. The manufacturing and testing requirements are based on DIN EN 1677-1, under consideration of the grade 100 forces.



Trade Size	Article-No.	Working Load Limit [t]	Normal straight load [daN]	Lashing Capacity (LC) [daN]	Dimensions [inch]			Weight app. [kgs]
					e_{max}	e_{min}	lift	
13-10	F341877	6,70	2.600	13.000	675	445	230	7,19
16-10	F341977	10,00	3.100	20.000	830	550	280	11,80

TWN 1454

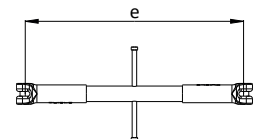

Chain Tensioners with Ratchet (Large Lift)

The grade 100 chain tensioners with ratchet TWN 1455 are used as tensioning elements in lashing chains. The chain tensioners can also be used in chain slings for stepless adjustment of strand lengths when lifting loads. The chain tensioners have a particularly large lift. The chain tensioners with ratchet and trapezoidal thread achieve a high pre-tensioning force with little force impact. This property is of fundamental importance when lashing down, as the level of the pre-tensioning force contributes to load securing. The manufacturing and testing requirements are based on DIN EN 1677-1, under consideration of the grade 100 forces.



Trade Size	Article-No.	Working Load Limit [t]	Normal straight load [daN]	Lashing Capacity (LC) [daN]	Dimensions [mm]			Weight app. [kgs]
					e_{max}	e_{min}	lift	
13-10	F341878	6,70	2.600	13.000	675	445	230	8,40

TWN 1455

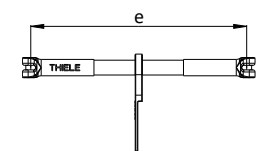



Grade 100 Lashing Chains and Components

TWN 1460

Lashing Chain Tensioners NEW

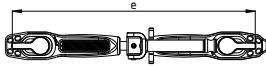

The grade 100 lashing chain tensioners with shortening claws on both sides TWN 1460 are used as tensioning elements in lashing chains. The chain tensioners can be positioned anywhere in the lashing chain and have a large clamping range. All functions (clamping, locking, unclamping) are carried out by the handy designed folding lever. Due to the folding lever, the chain tensioner is compact and requires little storage space. The chain tensioners enable a high pretensioning force with little effort due to the trapezoidal thread and comply with the DIN EN 12195-3. The manufacturing and testing requirements are based on DIN EN 1677-1, under consideration of grade 100 lashing forces.



Trade Size	Article-No.	Normal straight load [daN]	Lashing Capacity (LC) [daN]	Dimensions [mm]			Weight app. [kgs]
				e _{max}	e _{min}	lift	
8-10*	F34209	2.000	5.000	-	-	-	-
10-10	F34210	2.600	8.000	684	490	194	4,72
13-10*	F34211	3.000	13.400	-	-	-	-
16-10*	F34212	3.000	20.000	-	-	-	-

*On request



Patented anti-rotation safety device



Compact due foldable handle (small storage room)



Grade 100 Lashing Chains and Components

Lashing Points with two weld-on Brackets

The grade 100 weld-on lashing points with two weld-on brackets TWN 1473 have and are used for lashing of loads. The lashing points are predominantly welded to the vehicle frame (semi-trailers, trailers). The manufacturing and testing requirements are based on the DIN EN 1677-1, under consideration of the Grade 100 lashing forces.



Trade Size	Article-No.	Article-No. (Ring only)	Lashing Capacity (LC) [daN]	Dimensions [mm]										Weight app. [kgs]	
				d ₁	d ₂	b	a	l	e*	k	h	c	s		f
10-10	F352001	F352002	8.000	14	14	48	74	134	74	74	28	65	2	57	0,79
13-10	F352011	F352012	13.500	20	20	60	100	170	85	93	37	80	2	61	1,73

*Upright standing ring

TWN 1473

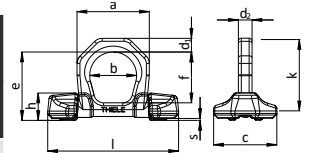

Pluggable Lashing Points

Pluggable lashing points according to TWN 1474 are used to secure loads on trucks. They are intended for temporary installation at the loading area. The lashing points consist of a forged pivot with welded B-link and a safety system consisting of a bolt and spring pin.

Installation for use is carried out by inserting the pin into the bearing bush from the loading area and securing it with the plug pin underneath the loading area.

When not in use, the lashing points are installed from underneath at the loading area, with the loading area being closed flush. The pin is marked with information of the maximum lashing capacity LC in daN, manufacturer's identification and traceability code.

The manufacturing and testing requirements are based on the DIN EN 1677-1



Article-No.	Lashing Capacity (LC) [daN]	Dimensions [mm]									Weight app. [kgs]
		d	f	t	b	e	d ₂	g	a	c	
F352255	8.000	16	58	70	35	99	26	51	45	197	0,99

TWN 1474

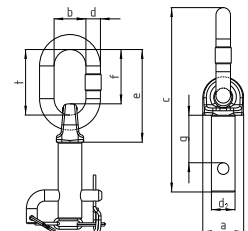

COMPACT Lashing Points with Spring

The grade 100 weld-on COMPACT lashing points with fixing spring TWN 1880 are used for securing of loads. The lashing points are predominantly welded in recessed skip fittings and on vehicle frames (semi-trailers, trailers). The compact design allows a small installation space. The manufacturing and testing requirements are based on the DIN EN 1677-1, under consideration of higher lashing forces.



Trade Size	Article-No.	Lashing Capacity (LC) [daN]	Dimensions [mm]									Weight app. [kgs]
			d ₁	d ₂	b	a	l	e*	h	c	f	
6-10	F35204	3.000	13	14	38	65	35	68	26	50	42	0,41
8-10	F35205	5.000	15	15	45	76	42	73	27	50	46	0,57
10-10	F35206	8.000	17	17	50	85	46	87	31	55	56	0,84
13-10	F35207	13.500	23	23	68	116	63	122	44	77	78	2,19
16-10	F35208	20.000	27	27	69	130	63	126	54	92	72	3,35

*Upright standing ring

TWN 1880

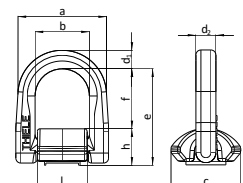

TWN 1890

XS-Points

The grade 100 screw-type XS-Points TWN 1890 are predominantly used in mold making, tool making and vehicle construction. The extra large D-links enable an easy assembling to other lashing components. The design of the XS-Points allows the use of variable screw lengths. The manufacturing and testing requirements are based on the DIN EN 1677-1. The bracket can be easily aligned in direction of force.

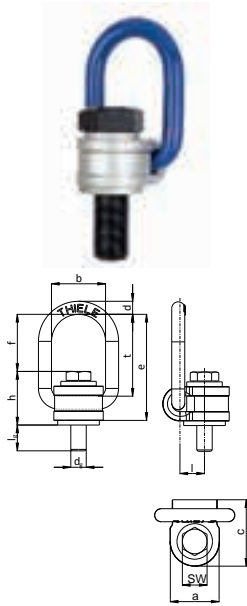

Screw Size d_g [mm]	Article-No.	Working Load Limit [t]	Thread Length l_g [mm]	Dimensions [mm]										Weight app. [kgs]
				e	f	c	l	t	b	h	d	SW	a	
M8 NEW	F352398	0,30	17	71	38	43	17	53	35	35	9	-	32	0,29
M10	F35243	0,63	17	71	37	43	17	53	35	35	9	16	32	0,29
M12	F35244	1,00	22	71	36	43	17	53	35	36	9	18	32	0,31
M16	F35245	1,70	28	98	46	64	25	70	50	52	13	24	48	0,96
M20	F35246	2,50	38	98	44	64	26	70	50	54	13	30	48	1,05
M24	F35247	4,00	40	135	70	71	28	102	58	65	16	36	50	1,69
M30	F35249	6,00	44	149	73	88	35	110	70	75	20	46	65	3,07
M36	F35250	8,00	64	149	70	88	35	110	70	79	20	55	67	3,55
M42	F35251	10,00	74	191	98	106	43	145	84	93	24	65	81	6,10

TWN 1820

XL-LOK Connecting Links

The grade 100 XL-LOK connecting links TWN 1820 are used to connect lifting chains with sling components to assemble chain slings and lashing chains. The manufacturing and testing requirements are based on the DIN EN 1677-1, under consideration of grade 100 load capacities.

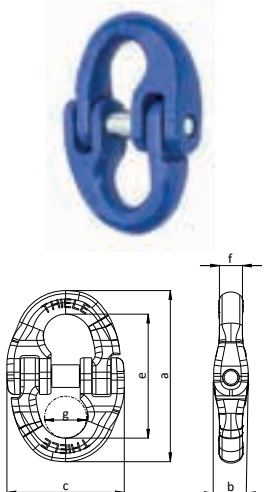

Trade Size	Article-No.	Working Load Limit [t]	Dimensions [mm]						Weight app. [kgs]
			a	b	c	e	f	g	
6-10	F30807	1,40	61	12	38,5	45	8	14	0,07
7-10	F308090	1,90	71	14,1	47	50,5	9	16	0,36
8-10	F30817	2,50	85	16	55	62	10	19	0,20
10-10	F30827	4,00	97,2	18	65,5	72	13	23,8	0,35
13-10	F30837	6,70	125,3	23	82,5	87,3	16,7	28	0,74
16-10	F30847	10,00	146,2	32	109	105	21	34,3	1,16

TWN 1851/1

Clevis Shortening Claws with Safety Pin **NEW**

The grade 100 clevis shortening claws with safety pin TWN 1851/1 are used to adjust the strand lengths of chain slings and lashing chains. The clevis design enables the direct attachment to the lifting chain. The safety pin prevents the chain strand from accidental release. The shortening claws have been tested in interaction with the lifting chain. The chain pockets ensure a particularly tight fit for the inserted chain link. The safety bolt enables the use in lifting chains according to DIN EN 12195-3. The manufacturing and testing requirements comply with the DIN EN 1677-1 and DIN 5692, under consideration of grade 100 load capacities.



Trade Size	Article-No.	Working Load Limit [t]	Dimensions [mm]				Weight app. [kgs]
			e	a	b	l	
6-10	F349141	1,40	51	27	37	78	0,25
8-10	F349241	2,50	65	34	46	100	0,50
10-10	F349341	4,00	81	43	56	124	0,94
13-10	F349441	6,70	106	56	73	162	2,03
16-10	F349551	10,00	130	68	88	198	3,61

Grade 100 Lashing Chains and Components

RAPID® Shortening Claws

The grade 100 RAPID® shortening claws TWN 1852 are used to adjust the strand lengths of chain slings and lashing chains. Due to the double claws, the RAPID® shortening claws can be universally integrated to existing chain strands without permanently mounting them into the chain. The shortening claws have been tested in interaction with the sling chains. The chain pockets ensure a tight fit of the inserted chain link. The safety bolt enables the use in lashing chains according to the DIN EN 12195-3. RAPID® shortening claws can be installed quickly and subsequently in lifting and lashing chains without tools. The manufacturing and testing requirements comply with the DIN EN 1677-1 and DIN 5692, under consideration of grade 100 load capacities.



Trade Size	Article-No.	Working Load Limit [t]	Dimensions [mm]			Weight app. [kgs]
			e	l	m	
8-10	F34775	2,50	111	148	48	1,11
10-10	F34780	4,00	134	180	60	3,09
13-10	F34785	6,70	179	240	78	4,76
16-10	F34790	10,00	222	296	96	9,07

TWN 1852

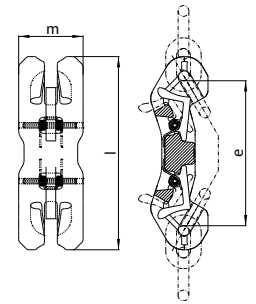

Clevis Shortening Hooks with Safety Pin

The grade 100 clevis shortening hooks with safety pin TWN 1827/1 are used to adjust the strand lengths of chain slings and lashing chains. The clevis design enables the direct attachment to the lifting chain. The safety pin prevents the chain strand from accidental release. The manufacturing and testing requirements comply with the DIN EN 1677-1 and DIN 5692, under consideration of grade 100 load capacities. The shortening hook has been tested in combination with the lifting chain. The extra wide chain support ensures a particularly firm fit for the inserted chain link. At the same time the link is protected from getting damaged. The safety bolt enables the use in lashing chains according to the DIN EN 12195-3.



NEW:
Application and assembly video for the shortening hook with safety pin on YouTube!

Trade Size	Article-No.	Working Load Limit [t]	Dimensions [mm]				Weight app. [kgs]
			e	g	l	b	
7-10*	NEW F332022	1,90	68,3	8,5	102,5	54	0,50
8-10	F33205	2,50	71	9,5	110	56	0,54
10-10	F33215	4,00	82,7	12,5	132	67	0,94
13-10	F33225	6,70	109	15,5	168	83	2,00
16-10	F33235	10,00	137	18,5	208	101	3,64

*on request

TWN 1827/1

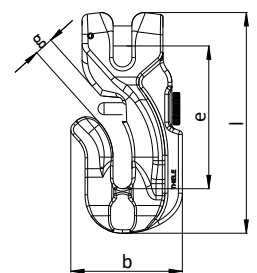

TWN 1869

Clevis Skip Suspension Links for One-Hand Operation and Forged Safety Latch

The grade 100 skip suspension links TWN 1869 connect chain slings with the pivots on containers, e.g. containers according to the DIN EN 30720. The shape of the eyelet is designed to fit container suspension pivots. The clevis design enables the direct attachment to the chain. The forged safety latch enables a one-hand operation. The manufacturing and testing requirements are based on DIN EN 1677-1, under consideration of grade 100 load capacities.

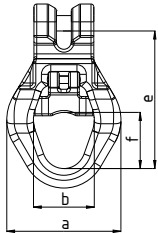

Trade Size	Article-No.	Working Load Limit [t]	Dimensions [mm]				Weight app. [kgs]
			e	f	b	a	
13-10	F313805	6,7	142	57,5	65	122	1,94

TWN 1840/1

Clevis Sling Hooks with Forged Safety Latch

The grade 100 clevis sling hooks with forged safety latch TWN 1840/1 are used to assemble standard chain slings and lashing chains. The clevis design enables the direct attachment to the lifting chain. The sling hooks comply with the DIN EN 1677-2, under consideration of grade 100 load capacities. Forged-in measuring points of the max. limit values of the hook opening enables easy control. The forged safety latch prevents an unintentional detachment from the load.

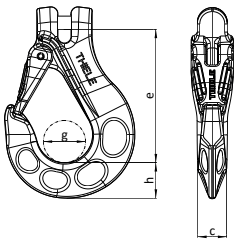

Trade Size	Article-No.	Working Load Limit [t]	Dimensions [mm]				Weight app. [kgs]
			e	g	h	c	
6-10	F336050	1,40	76	24	20	17	0,36
7-10*	NEW F336070	1,90	91	26,5	22	20	0,53
8-10	F336150	2,50	94	30	25	22	0,76
10-10	F336250	4,00	114	37	32	28	1,41
13-10	F336350	6,70	134	42	41	35	2,48
16-10	F336450	10,00	162	51	50	41	4,40

*on request

TWN 1899

Clevis Skip Suspension Hooks **NEW**

The grade 100 skip suspension hooks TWN 1899 connect chain slings with the pivot of containers, e.g. containers according to the DIN 30720. The shape of the hook opening is designed to fit container lifting pivots. The clevis design enables the direct attachment to the chain. The hooks lock automatically when under load and may only be re-opened manually if not under load anymore. The skip suspension hooks comply with the DIN EN 1677-3, under consideration of grade 100 working load capacities.

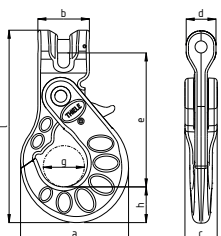

Trade Size	Article-No.	Working Load Limit [t]	Dimensions [mm]								Weight app. [kgs]
			e	c	g	h	d	b	a	l	
13-10	F335100	6,70	166	40	51	42	37	64	135	239	3,34

Grade 80 Lashing Chains and Components



When using the sling chains as a lashing chain, the maximum lashing force LC (Lashing Capacity) results by doubling the load capacity WLL (Working Load Limit): $LC = 2 \times WLL$.
 If the products are initially used for lifting, e.g. internal transport, up to the load capacity, they can still be used as lashing products. If lifting products are used for lashing, they may no longer be used for lifting anymore!

Lashing Chains with Tensioner

The grade 80 lashing chains with toggle and shortenable chain TWN 1400 have a standard length of 3,5 m and are used for heavy-duty lashing applications. The chain tensioners with toggle and trapezoidal thread achieve a high pre-tensioning force with little force impact. This property is of fundamental importance when lashing down, as the level of the pre-tensioning force contributes to load securing. The manufacturing and testing requirements are based on the DIN EN 12195-3.

Trade Size	Article-No.	Lashing Capacity (LC) [daN]	Weight app. [kgs]
8-8	F34171	4.000	8,50
10-8	F34172	6.300	12,50
13-8	F34173	10.600	21,00
16-8	F34174	16.000	37,70

Other lengths available on request.

TWN 1400



Lashing Chains with Ratchet

The grade 80 lashing chains with ratchet and shortenable lashing chain TWN 1401 have a standard length of 3,5 m and are used for heavy-duty lashing applications. The chain tensioners with ratchet and trapezoidal thread achieve a high pre-tensioning force with little force impact. This property is of fundamental importance when lashing down, as the level of the pre-tensioning force contributes to load securing. The manufacturing and testing requirements are based on the DIN EN 12195-3.

Trade Size	Article-No.	Lashing Capacity (LC) [daN]	Weight app. [kgs]
8-8	F34171R	4.000	8,50
10-8	F34172R	6.300	12,50
13-8	F34173R	10.600	21,00

Other lengths available on request.

TWN 1401





Grade 80 Lashing Chains and Components

TWN 0805

Lifting Chains

The grade 80 lashing chains TWN 0805 are made from CrNiMo alloy steel and are used to assemble chain slings and lashing chains. The max. application temperature is 400°C. The manufacturing and testing requirements of these high-quality lashing chains are based on the DIN EN 818-2 and comply with the German Statutory Accident Insurance test principle GS-HM 37



Trade Size	Article-No.				Working Load Limit [t]	Nom. Size d_n [mm]	Pitch p_n [mm]	Inside Width w_3 [mm] min.	Outside Width w_2 [mm] max.	Weight app. [kg/m]
	Self coloured	RAL 9005	Corrothiel	Electro galvanized						
6-8	F01452	F01453	F01454	F01448	1,12	6	18	7,80	22,20	0,82
7-8	F01458	F01459	F01457	F014601	1,50	7	21	9,50	25,90	1,10
8-8	F01464	F01465	F01429	F01433	2,00	8	24	10,90	29,60	1,46
10-8	F01469	F01470	F01450	F01445	3,15	10	30	13,00	37,00	2,26
13-8	F01474	F01475	F01476	F014781	5,30	13	39	17,40	48,10	3,76
16-8	F01479	F01480	F01487	F014821	8,00	16	48	20,80	59,20	5,70

Lashing chains are identical in construction to sling chains of the same grade and trade size.

When using the sling chains as a lashing chain, the maximum lashing force LC (Lashing Capacity) results by doubling the load capacity WLL (Working Load Limit): $LC = 2 \times WLL$.

An alternative use of the chains as lashing and sling chains is not permitted!



THIELE manufacturer identification, also marked on THIELE-Chains

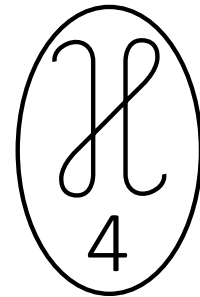

Approved Chain by the German Statutory Accident Insurance

TWN 1479

Lashing Links NEW

The Grade 80 lashing rings TWN 1479 are mainly fitted in brackets of C-shaped side frames on heavy-duty trailers. The crack tested lashing rings are used to secure loads in accordance with the DIN EN 12640 and DIN EN 12195-1 and enable the tie down of heavy loads of diverse shapes, such as construction equipment. The manufacturing and testing requirements are based on DIN EN 1677 Parts 1 and 4.

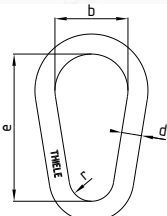

Trade Size	Article-No.	Lashing Capacity (LC) [daN]	Dimensions [mm]				Weight app. [kgs]
			d	t	b	b ₂	
10	F352354	10.000	17	125	62	38	0,59

Grade 80 Lashing Chains and Components

Chain Tensioners with Toggle

The grade 80 chain tensioners with toggle TWN 1450 are used as tensioning elements in lashing chains. The chain tensioners can also be used in chain slings for stepless adjustment of strand lengths when lifting loads. The manufacturing and testing requirements are based on the DIN EN 1677-1.



Trade Size	Article-No.	Working Load Limit [t]	Normal straight load [daN]	Lashing Capacity (LC) [daN]	Dimensions [mm]			Weight app. [kgs]
					e _{max}	e _{min}	lift	
8-8	F34179	2,00	1.800	4.000	345	270	75	2,10
10-8	F34199	3,15	2.200	6.300	375	275	100	2,70
13-8	F34189	5,30	2.600	10.600	460	330	130	4,00

If the products are initially used for lifting, e.g. internal transport, up to the load capacity, they can still be used as lashing products. If lifting products are used for lashing, they may no longer be used for lifting anymore!

TWN 1450

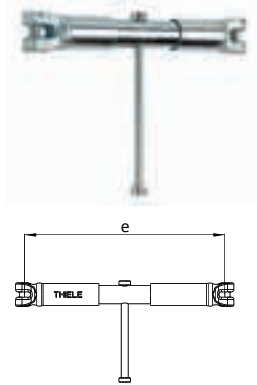

Chain Tensioners with Ratchet

The grade 80 chain tensioners with ratchet TWN 1451 are used as tensioning elements in lashing chains. The chain tensioners can also be used in chain slings for stepless adjustment of strand lengths when lifting loads. The manufacturing and testing requirements are based on the DIN EN 1677-1.



Trade Size	Article-No.	Working Load Limit [t]	Normal straight load [daN]	Lashing Capacity (LC) [daN]	Dimensions [mm]			Weight app. [kgs]
					e _{max}	e _{min}	lift	
8-8	F34175	2,00	1.800	4.000	345	270	75	2,50
10-8	F34195	3,15	2.200	6.300	375	275	100	3,50
13-8	F34185	5,30	2.600	10.600	460	330	130	5,00

If the products are initially used for lifting, e.g. internal transport, up to the load capacity, they can still be used as lashing products. If lifting products are used for lashing, they may no longer be used for lifting anymore!

TWN 1451

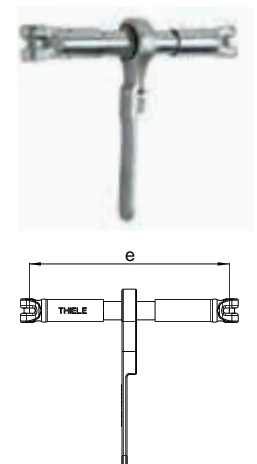

Chain Tensioners with Toggle (Large Lift)

The grade 80 chain tensioners with toggle TWN 1452 are used as tensioning elements in lashing chains. The chain tensioners can also be used in chain slings for stepless adjustment of strand lengths when lifting loads. The chain tensioners have a particularly large lift. The chain tensioner with ratchet and trapezoidal thread achieve a high pre-tensioning force with little force impact. This property is of fundamental importance when lashing down, as the level of the pre-tensioning force contributes to load securing. The manufacturing and testing requirements are based on the DIN EN 1677-1.



Trade Size	Article-No.	Working Load Limit [t]	Normal straight load [daN]	Lashing Capacity (LC) [daN]	Dimensions [mm]			Weight app. [kgs]
					e _{max}	e _{min}	lift	
13-8	F341871	5,30	2.600	10.600	675	445	230	7,20
16-8	F34197	8,00	3.100	16.000	830	550	280	11,80

If the products are initially used for lifting, e.g. internal transport, up to the load capacity, they can still be used as lashing products. If lifting products are used for lashing, they may no longer be used for lifting anymore!

TWN 1452

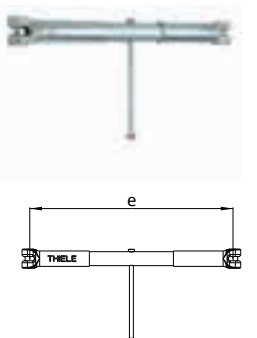

TWN 0119

Weld-on type Lifting Points

The weld-on lifting points TWN 0119 are used for universal lifting, moving and lashing of loads. The lifting points are often welded onto machine frames, steel constructions, lifting beams and housings. The manufacturing and testing requirements comply with the DIN EN 1677-1.

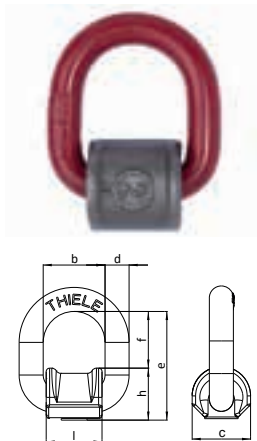

Trade Size	Article-No.	Working Load Limit [t]	Lashing Capacity (LC) [daN]	Dimensions [mm]							Weight app. [kgs]
				e*	f*	c	l	b	h	d	
6-8	F35103	1,12	2.200	59	31	32	32	36	28	12	0,24
8-8	F35113	2,00	4.000	69	36	38	38	42	33	14	0,46
10-8	F35123	3,15	6.300	85	46	45	44	48	38	18	0,72
13-8	F35133	5,30	10.600	120	69	60	60	66	51	24	1,93
16-8	F35143	8,00	16.000	127	66	68	65	72	61	28	2,67

*e- and f-Dimension vertical to the welding level.

TWN 0124

Weld-on type Lifting Points with Spring

The weld-on lifting points with spring TWN 0124 are used for universal lifting, handling and lashing of loads. The lifting points are often welded onto machine frames, steel constructions, lifting beams and housings. The D-ring is being held in position by a spring. The manufacturing and testing requirements comply with the DIN EN 1677-1.

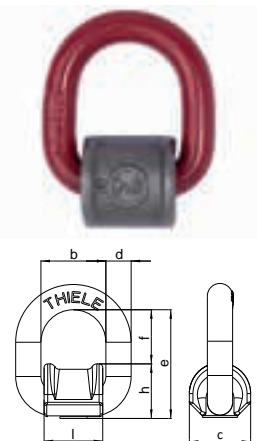

Trade Size	Article-No.	Working Load Limit [t]	Lashing Capacity (LC) [daN]	Dimensions [mm]							Weight app. [kgs]
				e*	f*	c	l	b	h	d	
6-8	F35107	1,12	2.200	57	29	32	32	36	28	12	0,24
8-8	F35110	2,00	4.000	67	34	38	38	42	33	14	0,46
10-8	F35124	3,15	6.300	81	43	45	44	48	38	18	0,72
13-8	F35139	5,30	10.600	117	66	60	60	66	54	24	1,61
16-8	F35144	8,00	16.000	122	61	68	65	72	61	28	2,67

*e- and f-Dimension vertical to the welding level.

TWN 1477

ZKS-Modules NEW

The weld-on ZKS-Modules TWN 1477 are predominantly installed in side frames of low-loaders and trailers. The large swivel range also allows the securing of overhanging loads. The pivotable lashing eyelet built into the cassette enables a fixed mounting position for easy connection with the lashing equipment. The manufacturing and testing requirements are based on the DIN EN 1677-1.

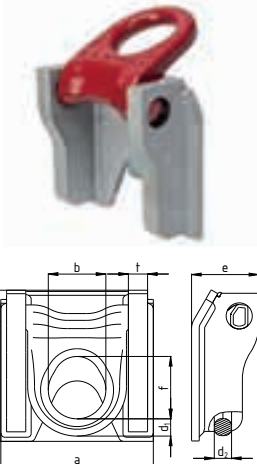

Trade Size	Article-No.	Lashing Capacity (LC) [daN]	Dimensions [mm]								Weight app. [kgs]
			d ₁	d ₂	b	a	t	e	c	f	
10	F352376	10.000	18	18	60	159	20	70	157,5	65	4,95

Lashing Points, Weld-on Type

TWN 1471

ZK-Modules with Stressless Lashing® NEW

The weld-type ZK modules TWN 1471 are predominantly installed in C-shaped side frames of low-loaders and trailers. The large swivel range also allows the securing of overhanging loads. A newly developed, patented cassette design enables a fixed mounting position for easy connection to the lashing equipment. Stressless Lashing® in perfection. The manufacturing and testing requirements are based on DIN EN 1677-1.

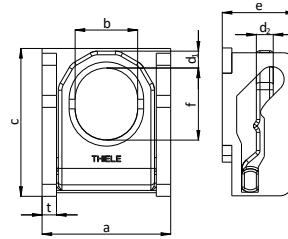

Trade Size	Article-No.	Execution*	Lashing Capacity (LC) [daN] max.	Dimensions [mm]								Weight app. [kgs]
				d ₁	d ₂	b	a	t	e	c	f	
5	F352390	N	5.000	14	14	52	107	12	61	119	60	1,92
5	F352395	S	5.000	14	14	52	107	12	61	119	60	1,95
10	F352380	N	10.600	18	18	62	137	15	73	144	78	3,45
10	F352385	S	10.600	18	18	62	137	15	73	144	78	3,46

* The sheets of the lashing cassette in the execution „N“ (=Normal) are produced in micro-alloyed steel. The execution „S“ (=Special) are produced from special steel and are therefore capable to get be hot dip galvanized (up to 500°C) with the vehicle frame.

General information

The standard DIN EN 12640 specifies the minimum testing requirements for lashing points on road trucks and trailers with flatbed bodies and a permissible total weight of more than 3,5 t for mixed cargo transportation. Lashing points are devices to attach lashing gear. A lashing point can be an oval link, hook, lug or lashing rail. These types of lashing points may lead to safety issues when in operation.

A non-appropriate dimensioning and use of non-suitable lashing points, as well as the damage of the lashing points and frames of the vehicle, shows a high potential danger in traffic. In operation, oval links are often exposed to unforeseen torque which may cause a damage to the body-work of the vehicles. Very often required inclination angles are not properly considered. Further, oval links can cause unnecessary noise exposure in traffic. The developed THIELE ZK-Modules (lashing ring with cassette) may be easily fitted and adopted at the side frames of trailers.

The ZK-Modules are marked with permissible lashing capacity (LC), manufacturer name (THIELE) and standard number (DIN EN 12640). Official agencies may easily check the correct installation. The ZK-Modules made by THIELE provides highest safety for load securing in the heavy-duty road traffic.



ZK-module on YouTube

Positions:



Rest Position



Hold Position



Position for oversized load



TWN 1320

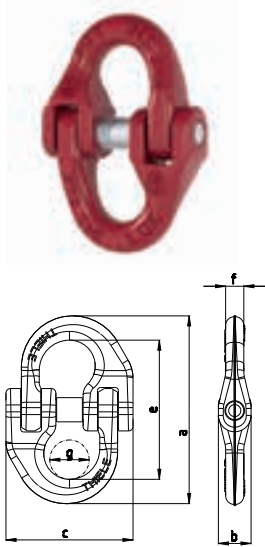

THI-LOK® Connecting Links

The grade 80 THI-LOK® connecting links TWN 1320 are used to connect chains with sling components to assemble chain slings and lashing chains. The manufacturing and testing requirements are based on the DIN EN 1677-1.

Trade Size	Article-No.	Working Load Limit $\beta = 0^\circ - 45^\circ$ [t]	Dimensions [mm]						Weight app. [kgs]
			e	g	a	c	b	f	
6-8	F308061	1,12	39	13	53	38	11	7	0,08
7-8	NEW F308151	1,50	47	16	65	48	13	8	0,12
8-8	F308161	2,00	54	18	74	53	14	9	0,17
10-8	F308261	3,15	64	22	88	62	18	12	0,29
13-8	F308361	5,30	86	26	118	77	23	15	0,62
16-8	F308461	8,00	102	36	141	100	29	19	1,16

TWN 0851/1

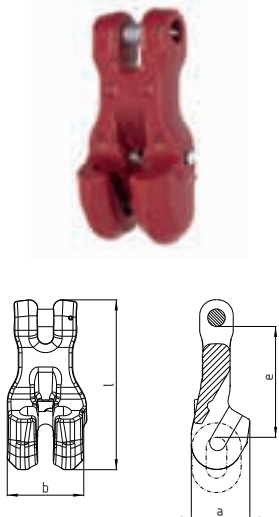

Clevis Shortening Claws with Safety Pin **NEW**

The grade 80 clevis shortening claws with safety pin TWN 0851/1 are used to adjust the strand length of chain slings and lashing chains. The clevis design enables the direct attachment to the lifting chain. The safety pin prevents the chain strand from accidental release. The manufacturing and testing requirements comply with the DIN EN 1677-1 and DIN 5692, under consideration of grade 80 load capacities. The shortening claws have been tested in interaction with the lifting chain. The chain pockets ensure a particularly tight fit for the inserted chain link. The safety bolt enables the use in lashing chains according to DIN EN 12195-3.

Trade Size	Article-No.	Working Load Limit [t]	Dimensions [mm]				Weight app. [kgs]
			e	l	b	a	
6-8	F349101	1,12	51	78	37	27	0,25
8-8	F349201	2,00	65	100	46	34	0,50
10-8	F349301	3,15	81	124	56	43	0,93
13-8	F349401	5,30	106	162	73	56	2,03
16-8	F349501	8,00	130	193	88	68	3,60

TWN 0827/1

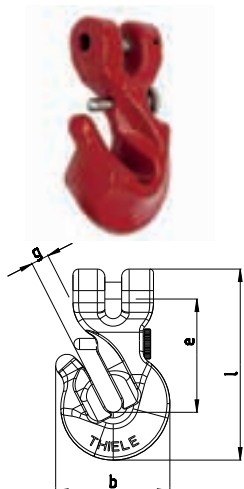

Clevis Shortening Hooks with Safety Pin

The grade 80 clevis shortening hooks with safety pin TWN 0827/1 are used to adjust the strand length of chain slings and lashing chains. The clevis design enables the direct attachment to the lifting chain. The safety pin prevents the chain from accidental release. The manufacturing and testing requirements correspond to the DIN EN 1677-1 and DIN 5692.

Trade Size	Article-No.	Working Load Limit [t]	Dimensions [mm]				Weight app. [kgs]
			e	g	l	b	
8-8	F33201	2,00	61	9,5	102	61	0,54
10-8	F33211	3,15	73	12	125	75	0,99
13-8	F33221	5,30	94	15	160	95	2,06
16-8	F33231	8,00	112	18	188	120	3,45

Grade 80 Lashing Chains and Components

Clevis Skip Suspension Links for One-Hand Operation and Forged Safety Latch

The grade 80 skip suspension links TWN 0869 connect chain slings with the pivot of containers, e.g. containers according to DIN 30720. The shape of the eyelet is designed to fit container suspension pivots. The clevis design enables the direct attachment to the lifting chain. The forged safety latch allows a safe one-hand operation. The manufacturing and testing requirements are based on DIN EN 1677 parts 1 and 4.

Trade Size	Article-No.	Working Load Limit [t]	Dimensions [mm]				Weight app. [kgs]
			e	a	f	b	
13-8	F313800	5,30	142	122	57,5	65	1,92
16-8	F313850	8,00	141	122	57,5	65	1,93

TWN 0869

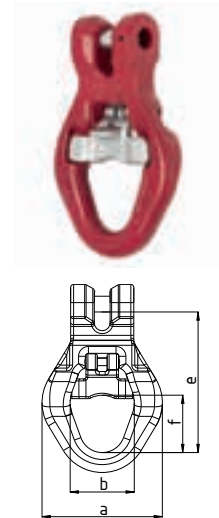

Clevis Sling Hooks with Forged Safety Latch

The grade 80 clevis sling hooks TWN 1340/1 are used for the assembling of universal chain slings and lashing chains. The clevis design enables the direct attachment to the lifting chain. The forged safety latch prevents an unintentional detachment from the load. The sling hooks comply with the DIN EN 1677-2.

Trade Size	Article-No.	Working Load Limit [t]	Dimensions [mm]				Weight app. [kgs]
			e	g	h	c	
6-8	F336010	1,12	76	24	20	17	0,36
8-8	F336110	2,00	95	30	25	22	0,76
10-8	F336210	3,15	114	37	32	28	1,41
13-8	F336310	5,30	134	42	41	35	2,48
16-8	F336410	8,00	162,5	51	50	41	4,40

TWN 1340/1

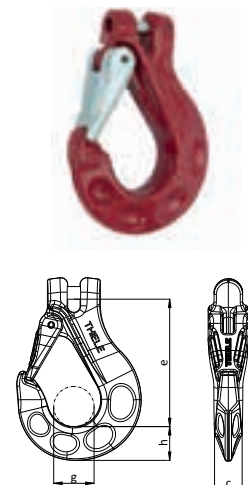

Clevis Skip Suspension Hooks NEW

The grade 80 skip suspension hooks TWN 1399 connect chain slings with the pivot of containers, e.g. containers according to DIN 30720. The shape of the hook opening is designed to fit container lifting pivots. The clevis design enables the direct attachment to the lifting chain. The hooks lock automatically when under load and may only be reopened manually if not under load anymore. The skip suspension hooks comply with the DIN EN 1677-3.

Trade Size	Article-No.	Working Load Limit [t]	Dimensions [mm]								Weight app. [kgs]
			e	c	g	h	d	b	a	l	
13-8	F335000	5,30	167	40	51	42	37	64	135	239	3,33
16-8	F335300	8,00	165	40	51	42	37	64	135	239	3,34

TWN 1399

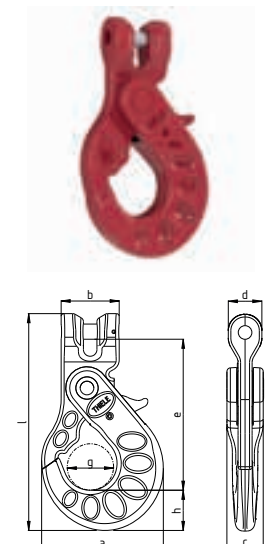



TM Lever Blocks TWN 1001

Properties:

- With overload protection *
- Light weight robust steel construction
- THIELE alloy load chain according to the DIN EN 818-7-T
- Minimized headroom
- Minimum effort needed to raise maximum load
- Hooks with strong casted safety latches
- Approved for tensioning according to the DIN EN 12195
- Protected automatic weston brake with unique twin pawls
- Galvanized hand chains
- Corrosion protection of galvanized load chains
- Durable baked enamel paint protection
- Standard spare parts available
- TÜV-/ GS-certified
- Supplied with THIELE test certificates
- Manuals available in 6 languages



The TM Lever Blocks TWN 1001 are hand operated, portable devices for pulling, lifting and moving of loads. They can also be used as lashing devices in accordance to the DIN EN 12195-3. The integrated slipping clutch works as over-load protection. The galvanized THIELE-load chains TWN 0062 comply with the requirements of the DIN EN 818-7.

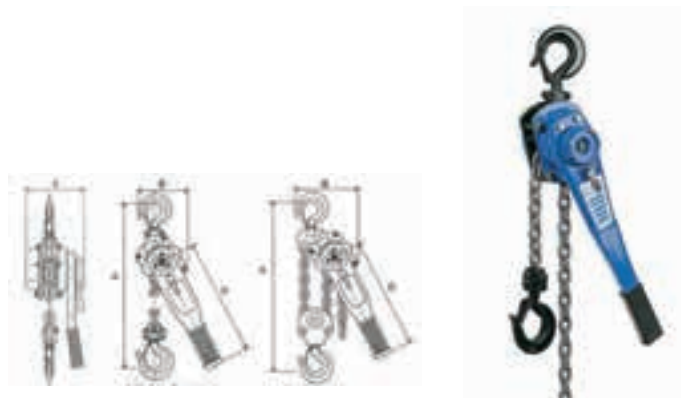

	Unit	TM-LB 025*	TM-LB-OP 075N	TM-LB-OP 150N	TM-LB-OP 300N	TM-LB-OP 600N
Working Load Limit / Lashing Capacity	[t]	0,25	0,75	1,5	3,0	6,0
Lift app. 1,50 m (5 ft.)	[Article-No.]	F061901	F062411	F062511	F062611	F062711
Lift app. 3,00 m (10 ft.)	[Article-No.]	F061902	F062412	F062512	F062612	F062712
Lift app. 4,60 m (15 ft.)	[Article-No.]	F061903	F062413	F062513	F062613	F062713
Lift app. 6,10 m (20 ft.)	[Article-No.]	F061904	F062414	F062514	F062614	F062714
Falls of chain	[pieces]	1	1	1	1	2
Effort to lift for max. Working Load	[kgs] max.	2,50	14,00	22,00	32,00	34,00
Load chain diameter	[mm]	4	6	8	10	10
Length of lever handle (D)	[mm]	160	280	410	410	410
Headroom (A)	[mm]	230	325	380	480	620
Width (B)	[mm]	85	136	160	180	235
Depth (C)	[mm]	92	148	172	200	200
Hook-opening (upper)	[mm]	25	42	46	54	62
Hook-opening (lower)	[mm]	25	42	46	54	62
Net weight (Lift app. 1,50 m)	[kgs]	2,37	7,10	13,20	21,75	32,97
Lever block only	[Article-No.]	F06192	F06243	F06253	F06263	F06273

*TM-LB 025 without overload protection



TGK

THIELE POULTRY CHAINS

Conveyor Chains for Slaughterhouses

Round Steel Chains for Poultry Industry TWN 0085

The calibrated TWN 0085 conveyor chains are used in the poultry industry, especially in slaughterhouses, as a central means for power and drive. The special THIELE case-hardening ensures a high wear resistance and the galvanized surface provides a high corrosion protection of the round steel chains. The manufacturing and testing requirements are based on manufacturer specific specifications.

The fine tolerated round steel chains are offered in standard lengths of 50 m.

THIELE provides screw-type connecting links (TWN 0086) to connect the chain lengths.

Dimension [mm]	Article-No.	Pitch p [mm]	Pitch-Tol. [mm]	Inner Width w_1 [mm] min.	Outside Width w_2 [mm] max.	Multi Pitch Length 11 x p [mm]	Multi Pitch Length Tol. [mm]	Weight app. [kgs/m]
8 x 25,3	F05470	25,3	-0,2/ +0,3	9,2	26,0	278,3	-0,0/ +1,0	1,40
8 x 25,4	F05471	25,4	-0,2/ +0,3	9,6	26,1	279,4	-0,4/ +0,6	1,32
8 x 38,0	F05472	38,0	-0,2/ +0,3	13,3	30,0	418,0	-0,0/ +1,1	1,20
10 x 38,0	F05473	38,0	-0,25/ +0,5	12,5	34,0	418,0	-0,5/ +1,4	2,00

Technical Properties:

Description	Nominal Size [mm]	Test Force [kN] min.	Breaking Force [kN] min.	Surface Hardness [HV1]	Hardening Depth at HV 550 [mm]	Surface Thickness [μ] min.	Compatible with*
T50E	8 x 25,3	24	40	min. 750	0,4 - 0,56	25	S
T50E	8 x 25,4	24	40	730 - 830	0,4 - 0,56	12	S, M, F, L
T80E	8 x 38,0	24	40	730 - 830	0,4 - 0,56	12	
T50E	10 x 38,0	37,5	62,5	730 - 830	0,5 - 0,70	12	
T80E	10 x 38,0	60	98	730 - 830	0,5 - 0,70	12	
T50V	8 x 25,4	24	40	min. 250	-	-	

Material-Options: Manganese Steel, Chrome-Nickel-Steel

***Feature:** suitable for S = "Marel Stork"; M = "Meyn", F = "FOODMATE"; L = "Linco"

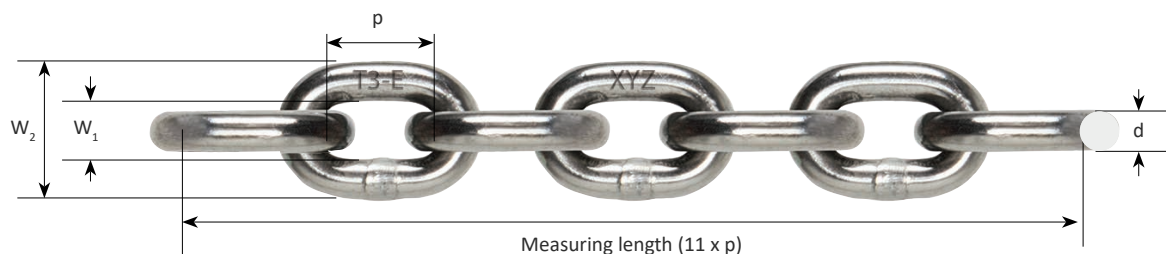

Finish: electro galvanized

Round Steel Chains made of corrosion-resistant Austenitic Steel TWN 0085

The round steel chain has been the central element in the power transmission in the poultry processing industry, especially for slaughterhouse operations. Round steel chains are being used on nearly all type of production lines, e.g. at slaughter, cutting and cooling lines.

The fine-tolerance round steel chains are made from austenitic steel and are offered in standard lengths of 50 m.

Dimension [mm]	Article-No.	Pitch p [mm]	Pitch-Tol. [mm]	Inner Width w_1 [mm] min.	Outside Width w_2 [mm] max.	Multi Pitch Length 11 x p [mm]	Multi Pitch Length Tol. [mm]	Weight app. [kgs/m]
8 x 25,4	F054711	25,4	-0,2/ +0,3	9,2	26,1	279,4	-0,4/ +0,6	1,32

Technical Properties:

Description	Dimension [mm]	Test Force [kN] min.	Breaking Force [kN] min.
T60R	8 x 25,4	37,5	60

Material: Corrosion-resistant austenitic steel (1.4404/316L or similar)

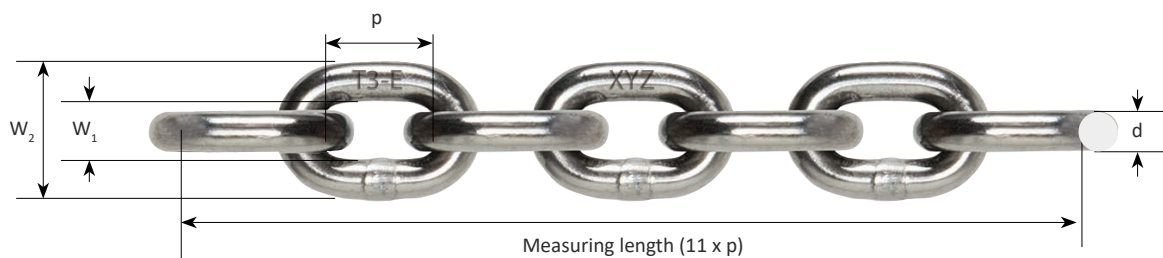

Finish: Bright finish

Screw-type Connecting Links TWN 0086

The screw-type connecting links TWN 0086 are used to connect the conveyor chains in poultry slaughterhouses easily. The special THIELE case-hardening ensures high wear resistance and the galvanized surface provides high corrosion protection of the connecting links. The manufacturing and testing requirements are based on manufacturer specific specifications.

Dimension [mm]	Article-No.	Pitch p [mm]	Inner Width w_1 [mm] min.	Outside Width w_2 [mm] max.	Breaking Force [kN] min.	Surface Hardness [HV10]	Hardening Depth at HV 550 [mm]	Weight app. [kgs/m]
8 x 25,4	F42077	25,4	9,3	26,1	30	550 - 600	0,2 - 0,3	0,034

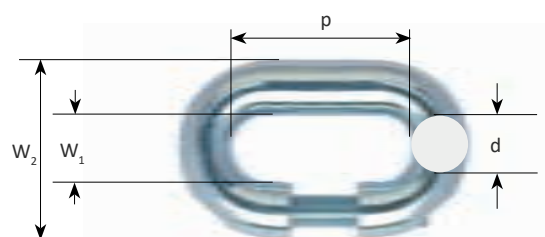

Finish: Electro galvanized



THIELE fine-tolerance round steel chains are manufactured with a high dimensional accuracy over a defined measuring distance.

Dimensional accuracy plays a decisive role and has a major impact on the operating life of the chain. Another important factor in ensuring a frictionless operation between the round steel chain and the drive and take wheels, is dimensional coordination to each other.

The two key factors that affect the service life of round steel chains are wear and corrosion.

THIELE uses a specific case hardening process to minimise the wear. The process applies carbon diffusion into the surface of the material in order to render the wear resistance of the chains.

Case Hardened Round Steel Chain 8 x 25,4 mm

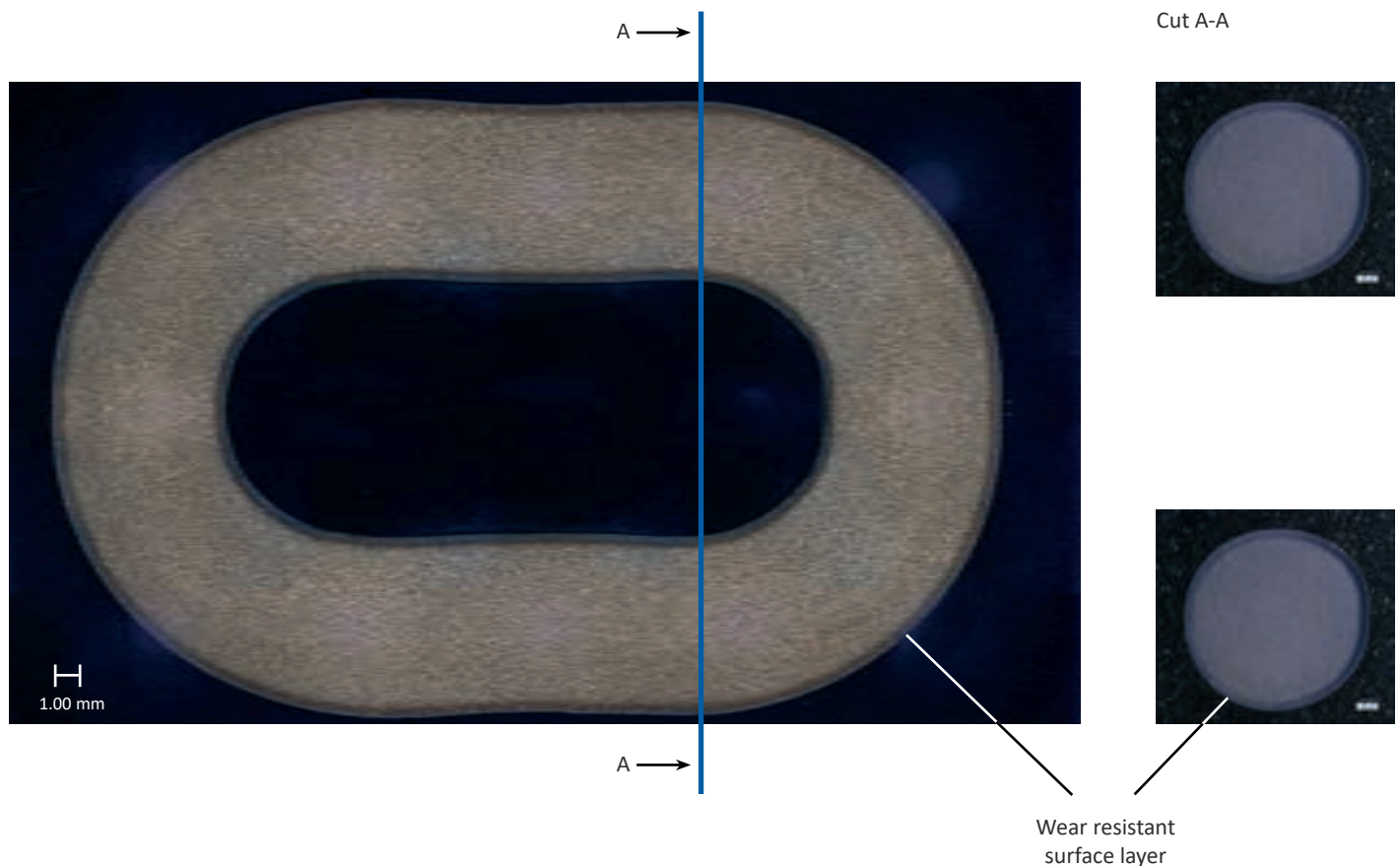

Round steel chains operating in slaughterhouse lines are exposed to chemical influences, such as cleaning agents. As a result, round steel chains are exposed to a continuous process of corrosion. Therefore, the round steel chains TWN 0085 are protected with a galvanic coating to counteract the effect of corrosion.

Poultry Chains

Wear

In operation, round steel chains are exposed to wear at the interlinks. The interlink wear causes a pitch elongation of the chain link and therefore of the complete conveyor chain.

Primary wear at the interlinks

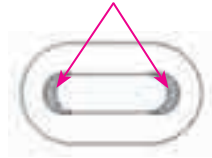

THIELE conveyor chains are produced with a corresponding surface hardness and hardening depth.

Discard criteria

Any frictional process will inevitably result in material loss, especially in the interlink areas. THIELE as a manufacturer recommends to take round steel chains out of operation once the total elongation over a defined length exceeds 2 %.

The definition of the discard criteria is calculated with the following formula, taking a measuring length of 11 link pitches into consideration:

$$\text{POINT OF DISCARD} = M_E > 2 \% M_L + M_L$$

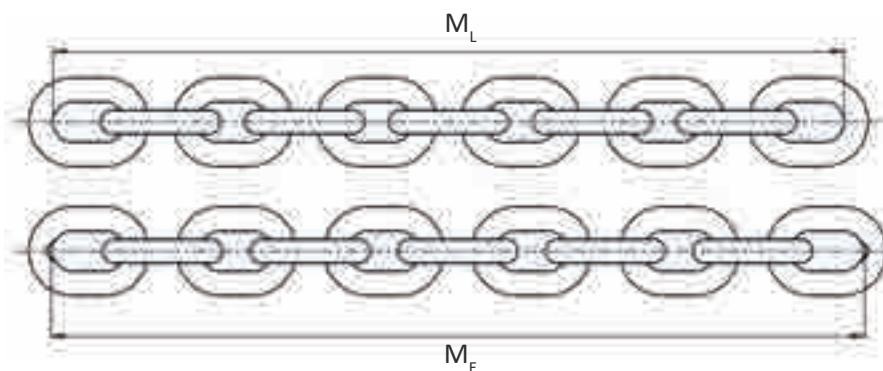

Legend:

M_E = actual measured test section in use (actual value)

M_L = Original length of the section (as per manufacturer specification)

To continue using the chain beyond this point of discard may result in an excessive wear of the chain and chain wheels. It may also cause functional failures which may lead to costly production downtimes.



Poultry Chains

The requirements imposed on the fracture mechanics of round steel chains are derived from the process parameters.

The speed and load conditions under consideration of the coefficients of friction and deflection, are essential to determine the breaking force requirements of the chains.

THIELE provides a range of different material grades and heat treatments for individual customer applications. They are precisely coordinated with the equipment manufacturer or plant operator on a case-by-case basis.

THIELE has experience in manufacturing round steel chains for poultry processing plants for many decades and work as the central element in power transmission.

THIELE Poultry Chains The central element in power transmission



Accessoires for Poultry Chains

THI-Rolls

The corrosion-protected and ball bearing-mounted rolls are made of high-quality POM. They are characterized by their high strength, hardness and rigidity, as well as high abrasion resistance.

Trade Size	Diameter [mm]	Width [mm]	Radius Tread (Crowning) [mm]	Material	Weight app. [kgs]	Compatible with	Type
D49	48,7	22,5	45	POM	0,05	Meyn	Clip design
D49	48,7	21,6	45	POM	0,05	Meyn	Srew design
D51	51,5	21,6	29	POM	0,06	Marel Stork	Srew design

Color: Blue, RAL 5017 other colors available on request



THI-Brackets (chain holder)

The high-quality THI-Brackets are made of PA and impress with their noise and vibration damping. The chain holder has a high abrasion resistance with high mechanical strength at the same time. With their recipes they are perfect suitable for the use in processing plants.

Height	Width [mm]	Depth [mm]	Distance Bracket parts [mm]	Material	Weight app. [kgs]	Compatible with	Type
110	50,5	30,0	62	PA	0,07	Meyn	Clip design
110	50,5	29,8	62	PA	0,06	Meyn	Srew design
110	50,5	29,8	62	PA	0,06	Marel Stork	Srew design

Color: Grey, other colors available on request



THI-Trolleys

The chain mounting bed of the THI-Trolley is specially designed for the chain geometry of the THIELE conveyor chains and provides a precise fit with screws and self-locking nuts made of rust- and acid-resistant material.

Height	Chain d x t [mm]	Distance between the rollers [mm]	Weight app. [kgs]	Compatible with	Type
110	8 x 25,4	≈ 19	0,27	Meyn	Srew design
110	8 x 25,4	≈ 19	0,23	Meyn	Clip design
110	8 x 25,3	≈ 19	0,27	Marel Stork	Srew design

Color: Grey, other colors available on request



THI-Trolleys mounted with chain and connecting links

The high-quality THI-trolleys are also offered assembled with the high-quality, special abrasion-resistant, heat-treated, corrosion-protected and true-to-gauge THIELE round steel chain. Standard distance: 6". Other distances (4", 8", 10" and 12") are possible. The first THI-Trolley is installed according to customer requirements.

The chains are delivered with a test certificate.

Height	Chain [mm]	Material	Breaking Force [kN]	Length [m]	Weight [kgs/m]	Compatible with	Type
110	8 x 25,4	Mn-Steel	40	50	3,1	Meyn	Srew design
110	8 x 25,4	Mn-Steel	40	50	3,1	Meyn	Clip design
110	8 x 25,3	Mn-Steel	37	50	3,2	Marel Stork	Srew design
110	8 x 25,4	Stainless Steel	40	50	3,1	Meyn	Srew design
110	8 x 25,4	Stainless Steel	40	50	3,1	Meyn	Clip design
110	8 x 25,3	Stainless Steel	40	50	3,2	Marel Stork	Srew design

Color: THI-Rolls: Blue, RAL 5017; THI-Trolleys: grey, other colors available on request





THIELE®



TLK

THIELE FARMING CHAINS

Conveyor Chains for Farming

TWN 5100/3

Round Steel Chains for Loading Wagons and Dung Spreaders

The round steel chains TWN 5100/3 are used in the loading floors of loader wagons and dung spreaders in the agriculture industry. The narrow dimensional tolerances of the calibrated round steel chains allow them to be used on loading floors with parallel 2 or 4 running chain strands (in pairs). The manufacturing and testing requirements are based on the specifications of the manufacturer THIELE.



Dimensions	Article-No.	Operating Force [kN] max.	Proof Force [kN] min.	Breaking Force [kN] min.	Measuring Length (11 x p)			Weight app. [kgs/m]
					[mm]	permissible tol.		
8 x 22,8	F05011	18	45,2	64,2	250,8	+1,1	-0,6	1,50
8 x 24	F05031	18	45,2	64,2	264,0	+1,2	-0,6	1,35
8 x 28	F05062	18	45,2	64,2	308,0	+1,4	-0,7	1,30
8 x 31	F05051	18	45,2	64,2	341,0	+1,5	-0,8	1,24
9 x 27	F05072	22,4	57,3	81,3	297,0	+1,3	-0,7	1,80
9 x 31	F05081	22,4	57,3	81,3	341,0	+1,5	-0,8	1,64
9,5 x 27	F05121	25	63,8	90,6	297,0	+1,3	-0,7	2,00
10 x 26,5	F05151	28	70,7	100	291,5	+1,3	-0,7	2,25
10 x 28	F05155	28	70,7	100	308,0	+1,4	-0,7	2,30
10 x 30,5	F05171	28	70,7	100	335,5	+1,5	-0,8	2,20
10 x 31	F05181	28	70,7	100	341,0	+1,5	-0,8	2,10
10 x 35	F05195	28	70,7	100	385,0	+1,7	-0,9	2,10
10 x 38	F05201	28	70,7	100	418,0	+1,9	-1,0	2,08
11 x 31	F05221	33,5	85,5	121	341,0	+1,5	-0,8	2,64
11 x 35	F05230	33,5	85,5	121	385,0	+1,7	-0,9	2,49
12 x 36	F05251	40	102	145	396,0	+1,8	-0,9	3,20
12 x 42	F05261	40	102	145	462,0	+2,1	-1,1	3,00
13 x 36	F05285	47,5	119	170	396,0	+1,8	-0,9	3,80
13 x 45	F05291	47,5	119	170	495,0	+2,2	-1,1	3,45
13,2 x 62	F05302	47,5	123	175	682,0	+3,1	-1,6	3,21
14 x 42	F05331	53	139	197	462,0	+2,1	-1,1	4,12
14 x 50 ²⁾	F131071	53	139	197	550,0	+1,1	-1,1	4,00
14 x 50 ^{2) 3)}	F131002	65	162	240	550,0	+1,1	-1,1	4,00
16 x 56	F05355	71	181	257	616,0	+2,8	-1,4	5,40

The length tolerance of chain strands for single strand is +0,3 / -0,0 %.

The length tolerance of matched pair chain strands is 0,1 %.

For the measurement of the length of matched pair chain strands, each chain strand must be free of torsion and strained or hanged with 1 % of the corresponding breaking force.

²⁾ Dimensional tolerances according to DIN 22252

³⁾ Increased tensile stress 200 N/mm², production test stress 500 N/mm² and breaking stress 720 N/mm²



Accessoires for Farming Chains

Special Connecting Links Type VG

The special connecting links type VG TWN 5200 are used to connect round steel chains in loader wagons and dung spreaders. The manufacturing and testing requirements are based on the specifications of the manufacturer THIELE.

TWN 5200 VG



Dimensions [mm]	Article-No.	Breaking Force [kN] min.	Weight app. [kgs]
8 x 24/ 8 x 22,8	F05500	70	0,066
8 x 31/9 x 31	F05510	85	0,079
8 x 28 *	–	85	0,079
9,5 x 27/ 10 x 26	F05531	90	0,095
10 x 28	F05541	100	0,100
10 x 30,5	F05550	100	0,100
10 x 31/ 11 x 31	F05551	100	0,130
10 x 35	F05555	100	0,100
10 x 38 *	F05560	100	0,100
11 x 35	F05564	100	0,100
12 x 36	F05574	140	0,240
13 x 36	F05570	170	0,240
13 x 45 *	F05575	170	0,255
14 x 42	F05568	190	0,145

* On request

Finish: Bright polished

Minimum order quantity: 50 pieces

Special Connecting Links Type VGG

The special connecting links type VGG TWN 5200 are used to connect round steel chains in loader wagons and dung spreaders. The manufacturing and testing requirements are based on the specifications of the manufacturer THIELE.

TWN 5200 VGG



Dimensions [mm]	Article-No.	Breaking Force [kN] min.	Weight app. [kgs]
8 x 31	F05520	85	0,068
10 x 31	F05551	100	0,130
11 x 35	F05556	100	0,130
12 x 42	F05573	140	0,145

Finish: Electro galvanized

Chain Brackets

The chain brackets TWN 0111 are used to connect round steel chains in loader wagons and dung spreaders and enable the mounting of flight bars. The manufacturing and testing requirements comply with the DIN 22253.

TWN 0111



Dimensions [mm]	Article-No.	Breaking Force [kN] min.	Weight app. [kgs]
14 x 50	F25006	190	0,675

With screw M16 x 65 as per DIN 931 ST 8.8 and nut as per DIN 985-1610, suitable for chains as per DIN 22252.



TWN 5201

Special Flight Bar Flanges

The special flight bar flanges TWN 5201 are used to fasten flight bars and round steel chains in loader wagons and dung spreaders. The manufacturing and testing requirements are based on the specifications of the manufacturer THIELE.



Dimensions [mm]	Article-No.	Breaking Force [kN] min.	Weight app. [kgs]
8 x 24/8 x 22,8	Z03598	MF8x22,8/24	0,016
8 x 31	Z03599	MF8x31	0,039
9,5 x 27	Z03600	MF9,5x27	0,053
10 x 31	Z03602	MF10x31	0,071
10 x 38	Z03603	MF10x38	0,055

Minimum order quantity: 50 pieces

TWN 5202

Special Hammerhead Screws

The special hammerhead screws TWN 5202 are used to fasten the flight bar flanges with flight bars and round steel chains in loader wagons and dung spreaders.

The manufacturing and testing requirements are based on the specifications of the manufacturer THIELE.



Dimensions [mm]	Article-No.	Breaking Force [kN] min.	Weight app. [kgs]
8 x 31	Z03868	HK 8	0,030
9,5 x 27	Z03870	HK 9,5x27	0,022
10 x 31	Z03871	HK 1010	0,035

Minimum order quantity: 50 pieces

TWN 5204

Special Drive Pocket Wheels

The special drive pocket wheels are mounted on shafts below the loading floors of loader wagons and dung spreader vehicles and are working as drive sprockets for the round steel chains. The manufacturing and testing requirements are based on the specifications of the manufacturer THIELE.



Dimensions [mm]	Article-No.	Type	Weight app. [kgs]
9 x 31	Z03584	58 B04	2,90



THIELE CHAIN SPROCKETS

Pocket Wheels



TKR



THIELE pocket wheels provide the perfect solution for creating an efficient drive system.

Chain wheels and system components are widely used in the light materials handling industry and complement the range of products in the conveying technology portfolio.

THIELEs fully modern plant and equipment pool is able to supply a wide range of components, including shafts, V-belt pulleys, one-piece and multi-piece chain sprockets and pocket wheels for drive and return systems.

THIELE pocket wheels and system components operate with round steel chains to provide perfectly matched solutions for all kind of applications.

The round steel chains are a durable and solid example of engineering that outperforms compared to the bushed conveyor chains and the fork link chains as a drive medium.

THIELE can draw on years of experience in the production, development and application of drive and tail sprockets and has produced system solutions for a whole portfolio of technically challenging situations.

The company has manufacturing facilities capable of producing components measuring 50 to 1,000 mm in diameter and 50 to 3,500 mm in width.

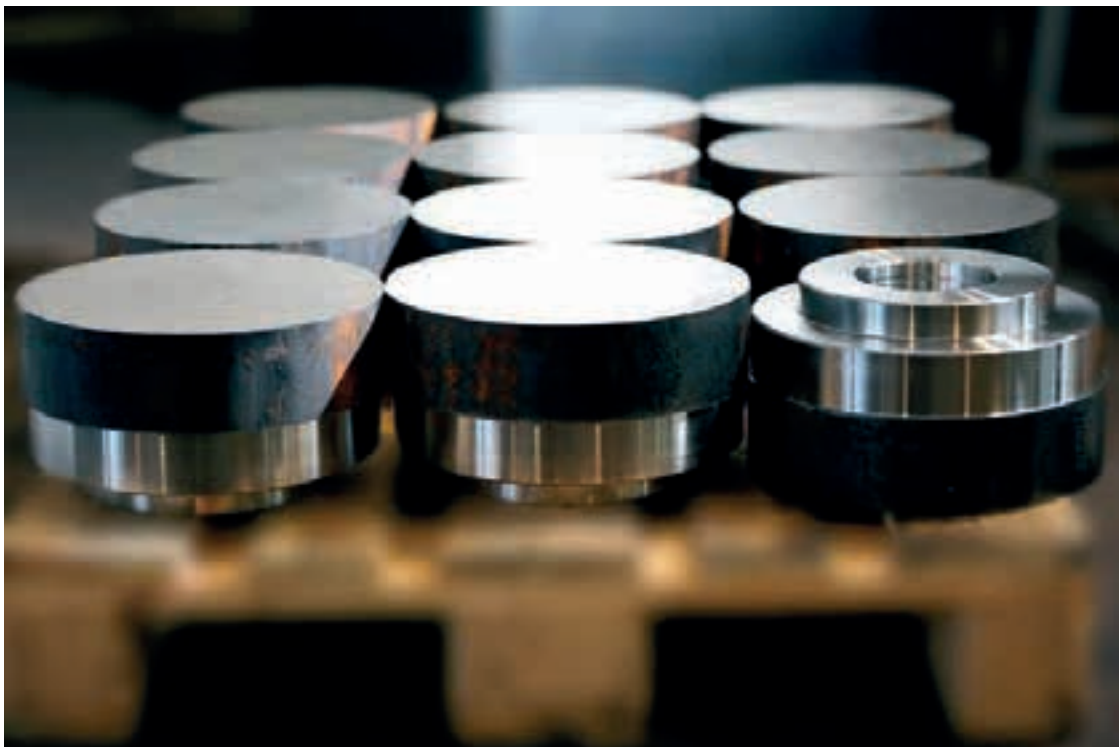

Chain Sprockets

Chain sprockets have multiple contact frequency compared to each chain link. Therefore, partially and inductive contour hardening is applied at the manufacturing stage to increase the wear-resistant properties of the sprockets.

The higher the number of teeth or chain sprockets, the more silent-running the chain and the lower the rate of wear as well as the degree of imbalance (polygon effect).



Marking:

Each sprocket wheel is marked with the manufacturer's name „THIELE“, the date of manufacturing, the nominal size of the round steel chains and a traceability code.

The latest FEM technology is used in the upstream design process to simulate the low-friction running behaviour generated between the round steel chains and the load-optimised sprocket wheels.



The choice of material essentially depends on the intended application and THIELE may select from a range of materials from C45 through to manganese, chromium alloy heat treated steel type 42CrMo4.

One-piece Pocket Wheels



Dimensions	No. of Pockets	Outer Diameter	Pitch Circle Diameter
[mm]	[i]	[mm]	[mm]
18 x 50	8	275	256,9
20 x 60	8	325	308,2
22 x 66	8	360	339
26 x 78	7	375	351,5
28 x 84	8	454	431,5
39 x 90	7	440	405,8
32 x 96	8	520	493,4
36 x 108	8	588	533,6
40 x 120	8	650	615,5
45 x 135	8	738	693,3

*The dimensions are exemplary. Execution as per customer specification.
Hub diameter and depth upon request.*

For dimensioning, please provide following data:

- Type of application
- Chain dimension
- Chain standard
- Number of pockets
- Pitch diameter
- Hub diameter
- Hub depth
- Type of fixing the pocket wheel to the shaft (e.g. keyway and key)

By using 3D-software any chain wheel or system component can be supplied tailor-made to customer requirements.

THIELE manufactures special chain wheels for practically every application that uses drive systems of this kind.

THIELE chain wheels can be machined from solid billet or produced as welded assemblies.

The design and manufacturing process essentially depends on what the individual customer has specified for the number of pockets, hub diameters and key/keyway drillings.

THIELE can supply any size of drive and tail sprockets for every kind of lifting and conveying system.



THIELE FISHING CHAINS

Round Steel Chains for the Fishing Industry



TFK

TWN 0081 ML/LL Fishing Chains



The mid-link and long-link round steel chains TWN 0081 are used to build nets in the fishing industry. The manufacturing and testing requirements are based on manufacturer specifications.

- Material according to DIN EN 818-2
- Elongation at break: min. 15 %
- Marking „T3“, „Germany“ and traceability code
- Finish: black coloured (RAL 9005)

Dimensions	Type	Article-No.	Diameter d [mm]	Pitch p [mm]	Inside width w ₃ [mm]	Outside width w ₂ [mm]	Breaking Force [kN] min.	Weight app. [kgs/m]
10 x 40	ML	F02881	10	40	13,5	15,0	126	2,00
13 x 55	ML	F02877	13	55	17,5	20,0	214	3,30
16 x 64	ML	F02875	16	64	21,5	24,0	322	5,10
19 x 76	ML	F02872	19	76	25,5	28,5	454	7,10
22 x 88	ML	F02878	22	88	29,5	33,0	610	9,60

Type "ML" = middle long link

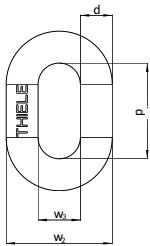

Dimensions	Type	Article-No.	Diameter d [mm]	Pitch p [mm]	Inside width w ₃ [mm]	Outside width w ₂ [mm]	Breaking Force [kN] min.	Weight app. [kgs/m]
13 x 81	LL	F02873	13	81	17,5	20,0	214	2,90
16 x 100	LL	F02876	16	100	21,5	24,0	322	4,40
19 x 100	LL	F02874	19	100	25,5	28,5	454	6,50
22 x 110	LL	F02871	22	110	29,5	33,0	610	8,80
26 x 140	LL	F02891	26	140	35,0	39,0	850	12,00
28 x 150	LL	F02879	28	150	38,0	42,0	986	14,00

Type "LL" = long link

TWN 0089/2 Fishing Chains



The short link round steel chains TWN 0089/2 are used in the fishing industry. The special THIELE hot-dip galvanizing ensures long-lasting corrosion protection. The dimensions and mass of the low-twist round steel chains match to the respective fishing net type. The manufacturing and testing requirements are based on manufacturer specification.

- Material according to DIN EN 818-2
- Elongation at break: min. 20 %
- Marking: „T3-7“, „THIELE“, „Germany“ and traceability code
- Finish: Hot-dip galvanized

Dimensions	Type	Article-No.	Diameter d [mm]	Pitch p [mm]	Inside width w ₃ [mm]	Outside width w ₂ [mm]	Breaking Force [kN] min.	Weight app. [kgs/m]
10 x 30	SL	F044861	10	30	13,0	37,0	102	2,20
13 x 39	SL	F0147621	13	39	17,4	48,1	162	3,76
16 x 48	SL	F0148011	16	48	20,8	59,2	252	5,70
17 x 48	SL	F028651	17	48	20,8	59,2	270	6,35
20 x 60 ¹⁾	SL	F014951	20	60	26,0	74,0	400	9,00
22 x 66 ¹⁾	SL	F015001	22	66	28,6	81,4	485	10,90

¹⁾ TWN 0089/1

Type SL = Short link

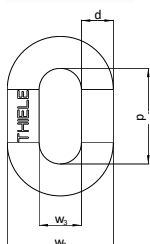



THIELE INSPECTION SERVICE

Mobile Inspection Service for Chains, Lifting
Components and Load Lifting Equipment



TPS



Inspection Service



UVV – Inspections



Maintenance



Dimension- and
Function tests



Repairs



Documentation



Crack tests



In addition to our product portfolio, THIELE offers a complete inspection service for work equipment which is subject to testing. THIELE service technicians are qualified by the German Society for Non-Destructive Testing (DGZfP) and examine your lifting equipment on site and in your factory and issue the test certificates.

With manufacture competence, we offer our customers a comprehensive service package:

- Inspections and wear measurements
- Electromagnetic crack testing
- Maintenance and repair
- Support for the assembling
- Commissioning
- Technical support
- Training of employees (expert training)
- Visual inspections
- Dimension- and function tests
- Crack tests

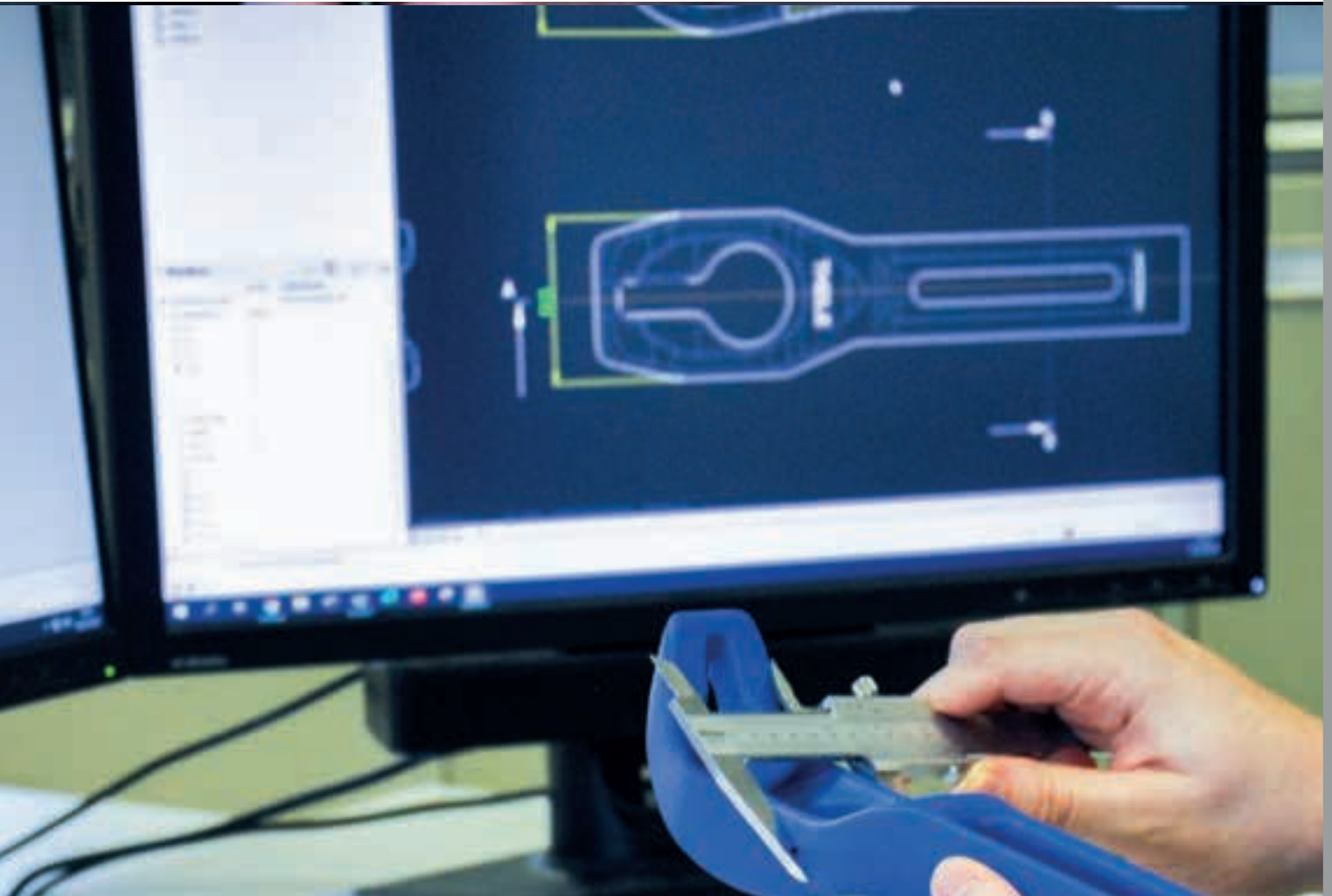

THIELE
ENGINEERING

Special Chains and System Solutions



TCE



THIELE Recycling-Solutions

THIELE Climate Protection Chains® and system components for the shredding technology:

THIELE Climate Protection Chains® impress with their high performance, high efficiency and long service life.

Based on many years of know-how in shredding technology for the recycling of refrigerators, e-waste, catalytic converters, etc., THIELE is in the position to offer our customers optimally coordinated system components.

The efficient shredding of refrigeration systems and e-waste is guaranteed with high-quality THIELE Climate Protection Chains®.

The range of dimensions includes round steel chains and chain components from 18 mm to 40 mm in diameter. Other customer-specific dimensions are available on request.

A targeted selection of materials and a special heat treatment guarantees high wear resistance and minimized downtimes.

Intelligent system solutions enable the exchange of components of the chain and reduces downtimes of the cross-flow shredder.

Our engineers in product development are looking forward to support you and convert customer requirements into exclusive tailor-made projects.

THIELE recycling systems achieve an economical disposal process.



A special heat treatment makes THIELE recycling solutions particularly high wear resistant.



Application example: Single links with chain holder welded type.

Our product portfolio:

- Single links
- Flattened single links
- Open connecting links
- Shackles
- End links (massive design)
- Screw type chain holders
- Welded type chain holders
- Cramps
- Block type side covers
- Bolts
- Guide bushes
- Customized chain heads



Special Chains

Suspension Chains for Mining and Tunneling

The long-link round steel chains according to DIN 20637 are mainly used for the suspension of the rail tracks of monorails and for pipelines and belt conveyors in mining according to the DIN 763.

The chains according to the DIN 15003 may not be used as load-bearing and load handling devices or in slings. The lengths of the round steel chains are delivered as per customer specification,

DIN 20637



Dimension [mm]	Diameter d_n [mm]	Pitch p_n [mm]	Pitch Tol. [mm]	Inner width w_1 [mm]	Outer width w_2 [mm]	Standard	Breaking Force [kN]	Weight app. [kgs/m]
6 x 42	6 +/- 0,3	42	+/- 1,3	10,80	25,20	DIN 763	12,50	0,63
8 x 52	8 +/- 0,4	52	+/- 1,6	14,40	33,60	DIN 763	25,00	1,10
10 x 65	10 +/- 0,5	65	+/- 2,0	18,00	42,00	DIN 763	40,00	1,75
13 x 82	13 +/- 0,65	82	+/- 2,5	23,40	54,60	DIN 763	63,00	2,95
16 x 80	16 +/- 0,6	80	+/- 1,5	22,40	56,00	DIN 20637	180,00	4,70
18 x 90	18 +/- 0,9	90	+/- 1,5	25,00	62,00	DIN 20637	250,00	6,00

Finish: self colored or electro galvanized

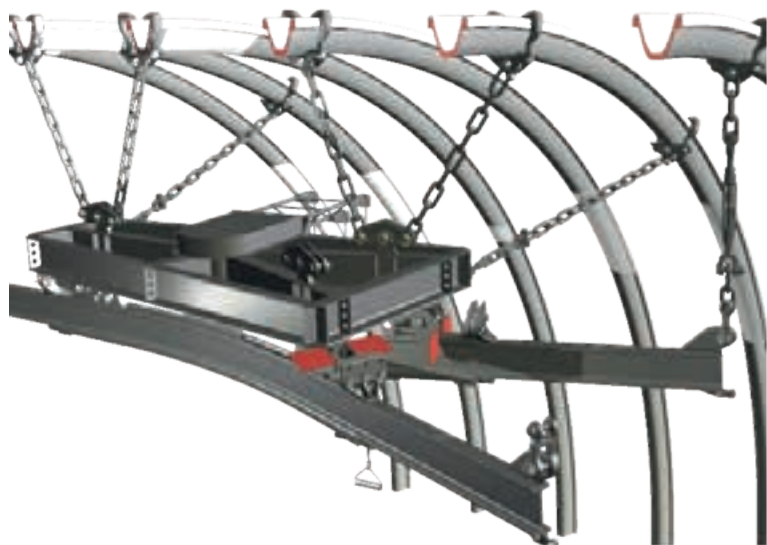
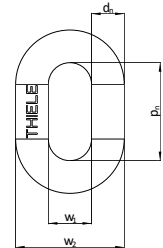

DIN 763

Long-Link Round Steel Chains

The long-link round steel chains according to the DIN 763 are predominantly used as suspension chains and may not be used as lifting devices, in slings or as supporting devices in the sense of the DIN 15003. The manufacturing and testing requirements are based on the specifications of the DIN 763.



Dimensions [mm]	Article-No.				Working Load Limit [t]	Weight app. [kgs/m]
	Finish					
	self col.	bright pol.	electro galv.	hot dipped galv.		
4 x 32	Z00013	F01013	F01011	F01019	0,10	0,27
5 x 35	F01032	F01035	F01038	F01041	0,16	0,43
6 x 42	Z00015	F01057	F01069	F01063	0,20	0,61
7 x 49	F01082	F01085	F01086	F01091	0,30	0,86
8 x 52	Z00019	F01107	F01110	F01113	0,40	1,10
10 x 65	F01126	F01129	F01134	F01135	0,63	1,68
13 x 82	Z02516	F01152	F01159	F01158	1,00	2,95
16 x 100	F01172	F01175	–	F01187	1,60	4,45

Supplied as standard in 30m bundles.

DIN 766

Calibrated Round Steel Chains

The calibrated round steel chains according to the DIN 766 are used in the entire field of technology as well as studless anchor chains and as a lifting device. The round steel chains are heat-treated and comply to the DIN 685-2. The manufacturing and testing requirements are based on the specifications of the DIN 766.



Dimensions [mm]	Article-No.				Working Load Limit [t]	Weight app. [kgs/m]
	Finish					
	self col.	bright pol.	electro galv.	hot dipped galv.		
10 x 28	F00273	F00258	F00261	F00260	1,25	2,30
11 x 31	F00306	F00300	F00303	F00321	1,60	2,70
13 x 36	F00395	F00380	F00383	F00376	2,00	3,90
16 x 45	F00460	F00463	F00466	F00464	3,20	5,80

Supplied as standard in 50m bundles.

THIELE also offers round steel chains for special applications such as:

- Chains for 2-wheel industry (locks)
- Heat resistant chains
- Conveyor chains for sugar cane industry
- Non-magnetic chains for maritim applications
- Customer specification

Please contact our sales team for further information and individual advice.

Phone: +49 (0) 2371 947 - 0
E-Mail: Lifting-Technology@thiele.de
Website: www.thiele.de

You can also use the contact form on our website www.thiele.de.

Index Register

Article.....	Grade	TWN	Page
Assembly Kit		TWN 0945	44, 87
Balancers	G80	TWN 0882	82
Bolt Shackles Type C	G80	TWN 0870	79
Bolt Shackles Type C with Nut and Roll Pin	G80	TWN 0871	80
Bolt Shackles Type C with Nut and Roll Pin	G100	TWN 1871	41
Bottom Load Hooks T.8N		TWN 1017	134
Bottom Load Hooks T.10N		TWN 1018	135
Calibrated Hand Chain			123
Calibrated Round Steel Chains		DIN 766	188
Chain Brackets		TWN 0111	175
Chain Coupling Links with Bolts.....	G80	TWN 0861	79
Chain Coupling Links with Bolts, Nut and Pin.....	G80	TWN 0862	79
Chain File.....		TWN 0944	44, 87
Chain Gauge Set		TWN 0946	87
Chain Gauges.....		TWN 1946	48
Chain Tensioners with Ratchet	G80	TWN 1451	81, 159
Chain Tensioners with Ratchet (Large Lift)	G100	TWN 1455	42, 151
Chain Tensioners with Toggle	G80	TWN 1450	80, 159
Chain Tensioners with Toggle (Large Lift)	G80	TWN 1452	81, 159
Chain Tensioners with Toggle (Large Lift)	G100	TWN 1454	42, 151
Clevis Foundry Hooks	G80	TWN 0859	73
Clevis Master Links	G100	TWN 1819	33
Clevis Self-Locking Hooks	G80	TWN 0799	71
Clevis Self-Locking Hooks	G100	TWN 1837	35
Clevis Shortening Claws.....	G80	TWN 0851	77
Clevis Shortening Claws.....	G100	TWN 1851	390
Clevis Shortening Claws with Safety Pin	G80	TWN 0851/1	78, 162
Clevis Shortening Claws with Safety Pin	G100	TWN 1851/1	40, 154
Clevis Shortening Hooks	G80	TWN 0827	77
Clevis Shortening Hooks	G100	TWN 1827	38
Clevis Shortening Hooks with Safety Pin	G80	TWN 0827/1	77, 162
Clevis Shortening Hooks with Safety Pin	G100	TWN 1827/1	39, 155
Clevis Skip Suspension Hooks.....	G80	TWN 1399	76, 163
Clevis Skip Suspension Hooks.....	G100	TWN 1899	37, 156
Clevis Skip Suspension Links for One-Hand Operation and Forged Safety Latch.....	G80	TWN 0869	76, 163
Clevis Skip Suspension Links for One-Hand Operation and Forged Safety Latch.....	G100	TWN 1869	38, 156
Clevis Sling Hooks with Forged Safety Latch.....	G80	TWN 1340/1	75, 163
Clevis Sling Hooks with Forged Safety Latch.....	G100	TWN 1840/1	36, 156
Clevis Suspension Links	G80	TWN 0820	68
COMPACT Lashing Points with Spring.....	G100	TWN 1880	117, 153
COMPACT Lifting Points with Spring.....	G100	TWN 1882	117
Container Pivots		TWN 0869/1	38, 76
Engine-Transport Clevis Hooks	G80	TWN 0889	75
Eye Foundry Hooks	G80	TWN 0856	72
Eye Foundry Hooks	G100	TWN 1856	37
Eye Foundry Hooks with Handle.....	G80	TWN 0856/1	73
Eye Self-Locking Hooks	G80	TWN 0798	71
Eye Self-Locking Hooks	G100	TWN 1836	34
Eye Sling Hooks.....	G80	TWN 0855	72
Eye Sling Hook with Safety Latch	G80	TWN 0855/1	72
Fishing Chains.....		TWN 0081	182
Fishing Chains.....		TWN 0089/2	182
Fixed-Size Master Links TAA1 for 1-leg Chain Slings	G80	TWN 0810/1	65
Fixed Size Master Links TAA1 for 1-leg Chain Slings	G100	TWN 1810/1	31
Fixed-Size Master Links TAA2 for 2-leg Chain Slings	G80	TWN 0810/2	65
Fixed-Size Master Links TAA2 for 2-leg Chain Slings	G100	TWN 1810/2	32
Fixed-Size Master Links TAA4 for 3- and 4-leg Chain Slings	G80	TWN 0810/4	65
Fixed-Size Master Links TAA4 for 3- and 4-leg Chain Slings	G100	TWN 1810/4	32
Fixed-Size Master Links TAB1 for 1-leg Chain Slings	G80	TWN 0811/1	66
Fixed-Size Master Links TAB2 for 2-leg Chain Slings	G80	TWN 0811/2	66
Fixed-Size Master Links TAB4 for 3- and 4-leg Chain Slings	G80	TWN 0811/4	66
Friction Discs T.16.....		TWN 1011	134
Friction Disk and Ratchet Disc Sets T.21N.....		TWN 1012	135
Hoist Chains Type DAT		TWN 0063	123
Hoist Chains Type T		TWN 0062	123

Index Register

Article.....	Grade	TWN	Page
Identification Tags for Lashing Chains		TWN 1402	45, 90, 149
Identification Tags for single- and multi-leg Chain Slings	G80	TWN 0940	86
Identification Tags for single- and multi-leg Chain Slings	G100	TWN 1940	48
Intermediate Links Type B	G80	TWN 0795	64
Intermediate Links Type B	G100	TWN 1795	31
Isolation Assemblies	G80	TWN 0893	83
Key Hooks	G80	TWN 0892	82
Lashing Chains with Ratchet.....	G80	TWN 1401	84, 157
Lashing Chains with Ratchet.....	G100	TWN 1411	43, 150
Lashing Chains with Tensioner	G80	TWN 1400	84, 157
Lashing Chains with Tensioner	G100	TWN 1410	43, 150
Lashing Chain Tensioners.....	G100	TWN 1460	152
Lashing Links.....	GK8	TWN 1479	158
Lashing Points with two weld-on Brackets	G100	TWN 1473	117, 153
Lifting Chains	G80	TWN 0805	63, 158
Lifting Chains XL200.....	G100	TWN 0072	28, 150
Lifting Chains XL400.....	G100	TWN 1805	27, 151
Lifting points THI-EYE	GK8	TWN 1490	116
Lifting Points with two weld-on Brackets	G100	TWN 1872	116
Long-Link Round Steel Chains		DIN 763	188
Magnet Chain Slings	G80	TWN 0601	83
Master Link Assemblies for 3- and 4-leg Chain Slings	G80	TWN 1314	69
Master Link Assemblies for 3- and 4-leg Chain Slings	G100	TWN 1814	29
Master Link Assemblies for 3- and 4-leg Rope Slings	G80	TWN 1315	70
Master Link Assemblies for 3- and 4-leg Rope Slings	G100	TWN 1815	30
Master Links Form A for 1- and 2-leg Chain Slings	G100	TWN 1813	29
Master Links Type A for 1- and 2-leg Chain Slings	G80	TWN 1313	69
MDB Lifting Points.....	G80	TWN 0127	109
Offshore Bolt Shackles Type C	G80	TWN 0818	100
Offshore Intermediate Links Type B	G80	TWN 0804	100
Offshore Lifting Chains	G80	TWN 0805	98
Offshore Master Link Assemblies for Wire Rope Slings.....	G80	TWN 0797	99
Offshore Master Links Type A.....	G80	TWN 0803	99
One-piece Pocket Wheels.....			180
Open Ring Shackles	G100	TWN 1847	34
Oversized Master Link Assemblies for 1-leg Chain Slings for Single Crane Hooks	G80	TWN 0815	67
Oversized Master Link Assemblies for 2-leg Chain Slings for Single Crane Hooks	G100	TWN 1816	30
Oversized Master Link Assemblies for 2-leg Chain Slings for Single Crane Hooks	G80	TWN 0816	67
Oversized Master Link Assemblies for 3- and 4-leg Chain Slings for Crane Hooks	G80	TWN 0817	68
Pipe Transport Hooks	G80	TWN 0868	74
Plate Hooks for Basket Chains	G80	TWN 0872	74
Plate Hooks for Spreader Chains	G80	TWN 0873	75
Pluggable Lashing Points		TWN 1474	153
RAPID® Shortening Claws	G100	TWN 1852	40, 155
Ratchet Discs T.17		TWN 1010	134
Ring Shackles.....	G80	TWN 0812	81
Ring Shackles.....	G100	TWN 1812	42
Round Steel Chains for Loading Wagons and Dung Spreaders.....		TWN 5100/3	174
Round Steel Chains for Poultry Industry.....		TWN 0085	166
Round Steel Chains made of corrosion-resistant Austenitic Steel.....		TWN 0085	167
Safety Latch Sets T.7N.....		TWN 1013	134
Safety Latch Sets T.9N.....		TWN 1014	135
Screw-type Connecting Links.....		TWN 0068	167
Screw-type Lifting Points	G80	TWN 0122	108
Screw-type Lifting Points	G80	TWN 0123	109
S-Hooks.....	G80	TWN 0860	74
Shortening Devices for Fixed Size Master Links.....	G80	TWN 0896	78
Shortening Devices for Fixed Size Master Links.....	G100	TWN 1896	41
Sling Hooks with Eye and Forged Safety Latch	G100	TWN 1841/1	36
SOLIDO® Eye Sling Hooks with forged Safety Latch	G80	TWN 0858/1	73
Spare Part Sets for Clevis Design	G80	TWN 0904/0	85
Spare Part Sets for Clevis Design	G100	TWN 0945	45
Spare Part Sets for Clevis Self-Locking Hooks	G100	TWN 1933/0	47
Spare Part Sets for Clevis Self-Locking Hooks	G100	TWN 1933/0A	47
Spare Part Sets for Clevis Shortening Claws	G100/G80	TWN 0971	45, 89

Index Register

Article.....	Grade	TWN	Page
Spare Part Sets for Hooks.....	G100.....	TWN 1908/0	46, 90
Spare Part Sets for RAPID®-Shortening Claws.....	G100.....	TWN 1931/0	47
Spare Part Sets for Self-Locking Hooks.....	G80.....	TWN 0967/0	88
Spare Part Sets for Self-Locking Hooks.....	G80.....	TWN 0967/1	88
Spare Part Sets for Self Locking Hooks.....	G100.....	TWN 1935	47
Spare Part Sets for Self Locking Hooks.....	G100.....	TWN 1935A	48
Spare Part Sets for Shackles Form C.....	G100.....	TWN 1930/0	46
Spare Part Sets for Shackles.....	G80.....	TWN 0905/0906	85
Spare Part Sets for Shackles.....	G80.....	TWN 0930	86
Spare Part Sets for Shortening Hooks	G80.....	TWN 0950-0952	87
Spare Part Sets for Shortening Hooks	G100.....	TWN 1950	48
Spare Part Sets for Skip Suspension Hooks and Links	G100/G80.....	TWN 0968	44, 89
Spare Part Sets for Skip Suspension Links.....	G80.....	TWN 0962	88
Spare Part Sets for Skip Suspension Links.....	G100/G80.....	TWN 0969	44, 45, 89
Spare Part Sets for Sling Hooks	G80.....	TWN 0920-0922	86
Spare Part Sets for THI-LOK® Connectors.....	G80.....	TWN 1920	90
Spare Part Sets for Weld-on Type Hooks	G80.....	TWN 0913	115
Spare Part Sets for Weld-on Type Hooks	G80.....	TWN 0949	116
Spare Part Sets for Weld-on Type Hooks	G80.....	TWN 1908/5	115
Spare Part Sets for XL-LOK Connectors	G100.....	TWN 1921	46
Spare Part Sets for XL-LOK Connectors	G100.....	TWN 1922	46
Special Chains for Loader Wagons and Dung Spreaders		DIN 22252	174
Special Connecting Links Type VGG		TWN 5200 VGG	175
Special Connecting Links Type VG.....		TWN 5200 VG	175
Special Coupling Shackles with Bolt, Nut and Roller Pin.....	G80.....	TWN 0897	80
Special Drive Pocket Wheels.....		TWN 5204	176
Special Flight Bar Flanges.....		TWN 5201	176
Special Hammerhead Screws.....		DIN 5202	176
Suspension Chains for Mining and Tunneling		DIN 20637	187
Swivel Adapters.....	G100.....	TWN 1846	43
Swivel Hooks	G80.....	TWN 0854	71
Swivel Lifting Points	G80.....	TWN 0121	108
Swivel Self-Locking Hooks	G100.....	TWN 1838	35
Swivels	G80.....	TWN 0845	82
T-Handle Chains	G80.....	TWN 0894	83
THI-Brackets (chain holder).....			171
THIELE Climate Protection Chains®.....			186
THI-LOK® Connecting Links	G80.....	TWN 1320	70, 162
THI-Rolls.....			171
THI-Trolleys			171
THI-Trolleys mounted with chain and connecting links			171
TM Chain Blocks.....		TWN 1000	132
TM Displays			133
TM Girder Clamps		TWN 0899	133
TM Lever Blocks		TWN 1001	132, 164
Top Load Hooks T.6N.....		TWN 1015	134
Top Load Hooks T.8N.....		TWN 1016	135
Towing Eyes acc. to DIN 74054		TWN 0301-0304	120
Towing Eyes acc. to DIN 74054		TWN 0308	120
Towing Eyes acc. to DIN 74054		TWN 0321	120
Towing Eyes acc. to DIN 74054		TWN 0323	120
Weld-on Hooks	G80.....	TWN 0850/1	114
Weld-on Hooks	G80.....	TWN 0850/2	115
Weld-on Hooks	G80.....	TWN 1380	115
Weld-on type Lifting Points.....	G80.....	TWN 0119	114, 160
Weld-on type Lifting Points with Spring.....	G80.....	TWN 0124	114, 160
XKE-Points.....	G100.....	TWN 1884	111
XL-LOK Connecting Links.....	G100.....	TWN 1820	33, 154
XS-Points	G100.....	TWN 1890	111, 154
X-TITAN Lifting Points.....	G100.....	TWN 1120	109
X-TREME Lifting Points.....	G100.....	TWN 1830	110
ZK-Modules with Stressless Lashing©	G80.....	TWN 1471 ..	118, 119, 161
ZKS-Modules	G80.....	TWN 1477	118, 160

THIELE GmbH & Co. KG

Werkstr. 3
58640 Iserlohn - Kalthof
Germany

Phone: +49 (0) 2371 947 - 0
Mail: Lifting-technology@thiele.de
Website: www.thiele.de

Follow us



Liability and Copyright

All information given is based on our current knowledge and expertise and is supplied without obligations or commitments. This also applies to the patent rights of third parties. We do not give any obligatory warranty in the legal sense as to the properties of the products described in this publication. We expressly reserve the right to change our specifications in accordance with technical progress and company developments. This does not release the buyer from his obligation to inspect all incoming products. The quality of all our products is of course guaranteed in accordance with our general terms and conditions of sale. The copyright for the published objects remains exclusively at the author of this document. Any duplication or utilization of such graphics or texts in other electronic or printed publications are not allowed without any agreement of the author.